



VELUX®

Product Brochure

UK Price List (excludes VAT)
3rd February 2020

velux.co.uk

First-class service

On average, we answer the phone within **one minute** and reply to emails within **24 hours**



+

We've been at the very forefront of innovative design in roof windows for **over 75 years**



+

Our products are tried, tested and **guaranteed**



+

We have a **zero defect philosophy** embedded into our workforce



+

Standard products available on a **2-day** lead time



+

We are **reducing** emissions, working towards zero-waste production and using more recycled materials



Front cover features: 2x GGL SK06 2070
(Instagram: e.t.shown_home)



VELUX®

Contents

Getting daylight right	4-5	VELUX INTEGRA® electric centre-pivot roof windows	32
Design inspiration		VELUX INTEGRA® solar powered centre-pivot roof windows	33
Your kitchen extension	6-7	Sloping and fixed combinations	34
Your extended living space	8-9	Sloping and vertical combinations	35
Your bedroom	10-11	Conservation roof windows	36
Replacing your roof windows	12-13	Rooflights for uninhabited spaces	37
Innovative products		Replacing and upgrading roof windows	38
What's new?	14	Installation products for sloping roof windows	39
VELUX ACTIVE	15	Sun tunnels	40
NEW! VELUX STUDIO roof window	16-17	Smoke ventilation systems	41
NEW! VELUX INTEGRA® electric top-hung roof windows	18-19	Flashings	
VELUX CABRIO® balcony	20-21	Recessed and standard flashings	43
VELUX bundles		Twin and combination flashings	44-45
Multi roof window bundles for extensions	23	Flat roof windows	
Multi roof window bundles for loft conversions	24	Curved glass rooflights	46
Single roof window bundles for loft conversions	25	Flat glass rooflights	47
Single roof window bundles for kitchens	26	VELUX flat roof domes	48
Single roof window bundles for living and dining rooms	27	VELUX flat roof domes – access and emergency escape	49
Sloping roof windows		NEW! VARIO by VELUX bespoke rooflights	50
Features and finishes	28-29	VELUX modular skylights	51
Centre-pivot roof windows	30	Blinds and accessories	
Top-hung roof windows	31	Blinds and shutters	52-64
		Accessories	65
		Size guide	66

For long-term peace of mind, choose VELUX. Please visit [velux.co.uk/registration](https://www.velux.co.uk/registration) to register your VELUX roof window guarantee.



CONTACT US

If you'd like more information on our range of VELUX products and services or you need technical support, we're here to help.

TELEPHONE: 01592 778 225
EMAIL: sales@velux.co.uk

Advice on product selection and installation instructions are also available on our website [velux.co.uk](https://www.velux.co.uk)

Getting daylight right

The ideal amount of natural light

Natural light is essential to your wellbeing. The size, as well as the number of windows is fundamental to how your space will look and feel. Combining VELUX roof windows with vertical glazing is important as it allows daylight to enter your home from different angles. For optimal comfort, we recommend that the glazed areas represent **15-20%** of the overall floor space in your room.

A SIMPLE CALCULATION



Here are some examples:

Floor space under the roof	Recommended glazed area	Distribution of the glazed area	Number and size of roof windows
10 m ²	$\times 15\% = 1.5 \text{ m}^2$		2 X PK08 roof windows or 3 X MK06 roof windows
15 m ²	$\times 15\% = 2.25 \text{ m}^2$		2 X UK08 roof windows or 3 X PK08 roof windows
25 m ²	$\times 15\% = 3.75 \text{ m}^2$		3 X UK08 roof windows or 4 X PK10 roof windows

The size chart opposite highlights the glazed area measurements that each of our standard VELUX roof window sizes will provide.

Full external size guide available on [p66](#). Other glazed area measurements available on request. Please contact our customer service team on **01592 778 225** for further information.

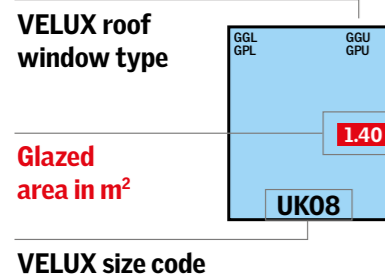

Dimensions of pitched VELUX roof windows	98	GGL GPL	GGU GPU		GGL GPL	GGU GPU
		0.47			0.91	
		MK04			UK04	
	118	GGL GPL	GGU GPU		GGL GPL	GGU GPU
	0.59			0.94		
	MK06			SK06		
140	GGL GPL	GGU GPU	GGL GPL	GGU GPU	GGL GPL	GGU GPU
	0.72	0.92	1.16	1.40		
	MK08	PK08	SK08	UK08		
160		GGL GPL	GGU GPU			
		1.07				
		PK10				
	cm	78	94	114	134	



DAYLIGHT IN YOUR HOME



You can never have too much daylight in your home. It will always make the space lighter and brighter.

Using our recommended calculation, the above images highlight the percentage of daylight achieved in each scenario and the effect multiple roof windows can have in a room.

Your kitchen extension – A beautifully light functional space

VELUX INTEGRA® electric roof windows transformed this room into a stunning and bright kitchen. Without roof windows, this room lacked direct sunlight because light from vertical patio doors has a limited reach. After VELUX roof windows were planned into this project, they brought in twice as much daylight – now it's a welcoming kitchen with room to cook, entertain and spend time with family.

Add VELUX ACTIVE to your VELUX INTEGRA® roof windows for optimum comfort and ease.

Featured VELUX roof windows: GGU PK10 007021U.



DAYLIGHT SOLUTIONS

To achieve the optimum daylight design, consider the size and function of the room and where daylight will be needed.



A single roof window will not spread the light throughout the whole room.



With 2 or more roof windows you can brighten the entire room and allow the daylight to reach deeper into the space.

VELUX RECOMMEND

VELUX INTEGRA®

Electric roof windows give you automation at the touch of a button. Controlling the temperature in your room has never been so easy.

Find out more on [p32](#) →

WHITE POLYURETHANE

Moisture-resistant and maintenance-free, perfect for humid kitchens.

LAMINATED GLAZING

Safety glazing will prevent glass falling into your home in case of breakage.

PLEATED BLIND

Available in both electric or solar powered options, pleated blinds are ideal for any contemporary kitchen.

Choose the perfect kitchen product bundle for your home.

See [p26](#) for more details.



VELUX INTEGRA®
electric
centre-pivot white
polyurethane roof
window.

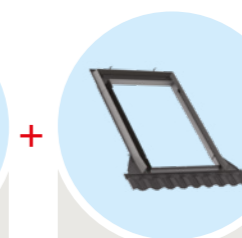

Suitable flashing
kit for your
roofing material.

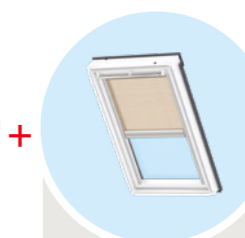

VELUX
INTEGRA®
electric
pleated blind.

Your extended living space – Adding the right amount of natural light

This dining room would have been quite gloomy without VELUX roof windows. As they are out-of-reach, VELUX INTEGRA® roof windows are the perfect choice, giving you daylight and fresh air at your fingertips. These can be easily opened or closed at the touch of a button.

Consider adding VELUX ACTIVE to your VELUX INTEGRA® roof windows, allowing you control from your smart phone.

Featured VELUX roof windows: GGL PK10 207021U.



DAYLIGHT SOLUTIONS

To maximise daylight, consider the balance between vertical glazing and roof windows carefully.



Bifold doors will bring daylight in from one particular angle.



Combine bifold doors with 2 or more roof windows to fill the space with twice the amount of daylight.

VELUX RECOMMEND

VELUX INTEGRA®

Electric roof windows give you control at the touch of a button, perfect for out-of-reach areas.

Find out more on [p32](#) →

WHITE PAINTED

Bright white finish with discreet wood grain requires less maintenance.

LAMINATED GLAZING

Safety glazing will prevent glass falling into your home in case of breakage.

PLEATED BLIND

VELUX pleated blinds are a great solution for practical living spaces, softening incoming light on a sunny day.

Choose the perfect living/dining room product bundle for your home. Turn to [p27](#) for further details.



VELUX INTEGRA® electric centre-pivot white painted roof window.

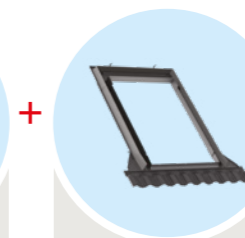

Suitable flashing kit for your roofing material.

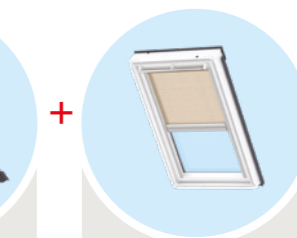

VELUX INTEGRA® electric pleated blind.

Your bedroom – A bright and airy space

This bedroom was created by transforming an unused loft space. Installing both sloping and fixed VELUX roof windows not only adds a real wow factor, it dramatically increases the level of daylight flooding into the room. As well as a means of escape during an emergency, these top-hung roof windows allow stunning, uninterrupted views.

Featured VELUX roof windows: GPL PK08 2066 combined with a GIL PK34 2066 with DKL PK08 0705 & DKL P04 0705 blackout blinds.



Download the **VELUX MyDaylight App** to your phone and visualise how your own loft space could look with added daylight through the roof.

DAYLIGHT SOLUTIONS

Ensure you consider the number of roof windows to maximise the potential of your loft.



A single roof window will bring in some daylight, but not the optimal amount.



With 2 or more roof windows you can brighten the whole room with more daylight.

VELUX RECOMMEND

TOP-HUNG ROOF WINDOWS

Enjoy panoramic, uninterrupted views.

Find out more on [p31](#) →

WHITE PAINTED

Matches perfectly with modern interiors.

NOISE REDUCTION GLAZING

Noise reduction glazing is perfect for a good night's sleep.

BLACKOUT BLIND

VELUX blackout blinds offer blackout for darkness at any time.

Choose the perfect bedroom product bundle for your home. Turn to [p25](#) for further details.

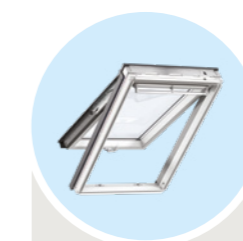

Top-hung
white painted
roof window.

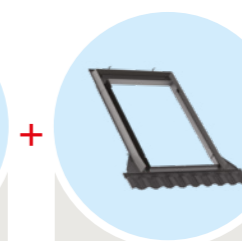

Suitable flashing kit
for your roofing
material.

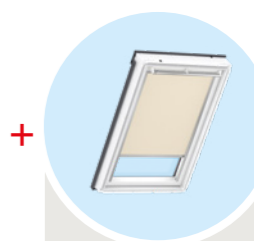

VELUX manual
blackout blind.

Time for an upgrade?

Replacing your VELUX roof windows is simple

We have been manufacturing roof windows for 75 years. In that time a lot has changed – materials and technology have moved on and so have VELUX roof windows.

Featured VELUX roof window:
GGL MK08 2068.



Certified
Installer

VELUX®

Find a VELUX Certified Installer near you:

[velux.co.uk/findaninstaller](https://www.velux.co.uk/findaninstaller)

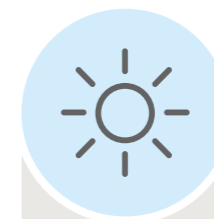

Gain up to **10%**
more daylight



Up to **115%** more
energy efficient



Replacement in as
little as **4hrs**

SIMPLE

- Same standard VELUX sizes available.
- Replacement in as little as 4 hours.
- Fitted quickly and easily from inside your room.
- Minimal mess and disruption to internal finish.

SMART & STYLISH

- White painted finish suits modern interiors.
- Increased range of accessories, including maintenance kits and security locks.
- Replace with VELUX INTEGRA® roof windows which can be operated at the touch of a button.
- Upgrade manual roof windows to VELUX INTEGRA® solar powered operation with an easy-to-install conversion kit.

When replacing your roof windows, this is the time to ensure you achieve the right amount of daylight. To check you have the right number and size of roof windows please refer to our guide on [p4-5](#).



Find out more about replacement roof windows on [p38](#) →

For more inspiration...

To find the best replacement roof windows for you, visit [velux.co.uk/replacement](https://www.velux.co.uk/replacement) and use our replacement configurator.

What's new?

As market leaders in innovation, we are continuously developing our product range. We are proud to announce the launch of our exciting new products below. Now there's even more opportunity to bring daylight, fresh air and style into your home.



VELUX STUDIO

The new VELUX STUDIO **3-in-1** roof window gives you the benefit of three roof windows within one easy installation. The opening side elements allow for the perfect amount of ventilation.

Find out more on [p16](#) →



VELUX INTEGRA® electric top-hung roof windows

Easy to use, these roof windows offer total control at the touch of a button. This makes it even easier to get the most of those beautiful panoramic views.

Find out more on [p18](#) →



VELUX ACTIVE

VELUX ACTIVE works together with your VELUX INTEGRA® roof windows, blinds and shutters, adjusting them automatically so your family enjoys a healthier indoor climate.

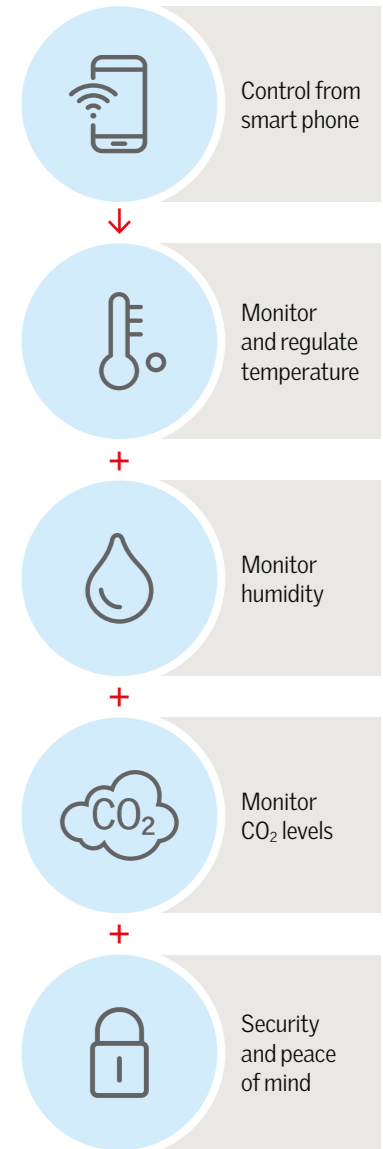
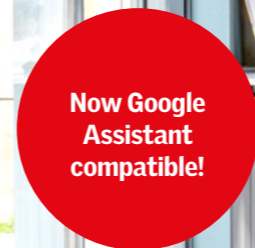

Code	Description	Price
VELUX ACTIVE kit		
KIX 300	Kit includes indoor climate sensor, departure switch and gateway.	£183.33
Additional components for multiple rooms		
KLA 300	VELUX ACTIVE indoor climate sensor.	£73.33
KLN 300	VELUX ACTIVE departure switch.	£35.83

▶ VELUX ACTIVE kit and components have a lead time of 5 days
 ▶ Delivery time is in working days from receipt of orders placed before 4pm (UK) and 11.30am (NI).

VELUX ACTIVE

Smart sensor-based operation of your VELUX roof windows, blinds and shutters.

with **NETATMO**

Compatibility lets you use voice control to operate your VELUX INTEGRA® products for the ultimate in convenience.



iPhone, iPod and iPad are registered trademarks of Apple Inc. Registered in the US and other countries. HomeKit is a trademark of Apple Inc. Google and Google Play are trademarks of Google LLC.

Benefits:

- One frame with multiple sashes for easy installation.
- Extra slim profiles for aesthetic look, enhanced view and maximum daylight.
- Triple glazed option available for added insulation.
- More cost effective than purchasing three single roof windows of the same size.

Roof pitch



Suitable for roof pitches between 15° and 90°.



NEW!



VELUX STUDIO

One frame. More than three times the daylight.

The new VELUX STUDIO 3-in-1 roof window will become a natural focal point in your home, providing you with a bright and light-filled space with real wow factor. Perfect for loft conversions and extensions.



1837 x 1178

External frame size (nominal w x h) mm

Code	Glazing	3x GGL FK06
White painted pine		
GGLS WK06 206650 U-value 1.2 W/m²K	VELUX STUDIO window. 3 roof window sashes in a single frame. Triple glazed.	£1,347
GGLS WK06 207050 U-value 1.5 W/m²K	VELUX STUDIO window. 3 roof window sashes in a single frame. Double glazed.	£1,017
EDWS WK06 303150	Flashing for VELUX STUDIO roof window. Suitable for tiles up to 120mm thick.	£320
EDLS WK06 303150	Flashing for VELUX STUDIO roof window. Suitable for slate up to 8mm thick.	£320

Available accessories:

- Internal blinds available in either solar powered or manual operation.
- Compatible with VELUX INTEGRA® solar powered conversion kits. Can be retro-fitted at any time.

- ▶ Studio roof windows and flashings have a delivery time of 2 days except GGLS 206650 which is 7 days.
- ▶ Delivery time is in working days from receipt of orders placed before 4pm (UK) and 11.30am (NI).

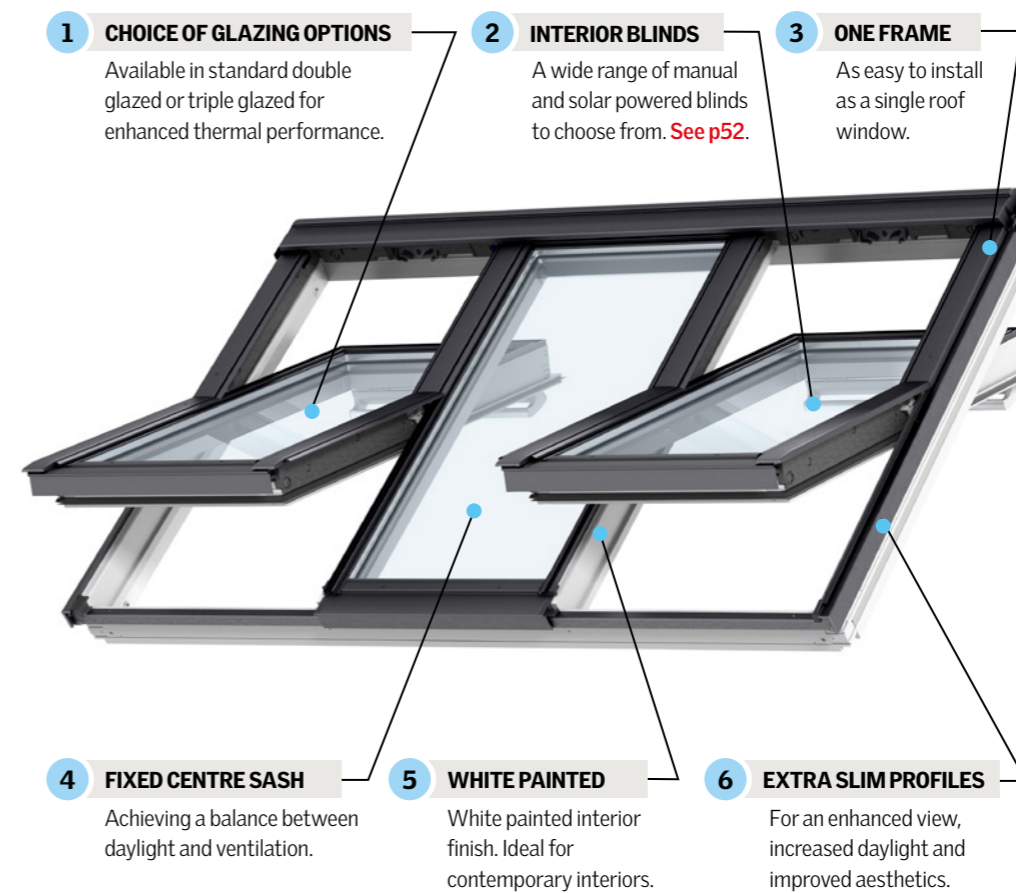

Flood your home with daylight

As standard we recommend that the glazed areas within a room represent **15-20%** of the overall floor space.

Please refer to our guide on getting daylight right in your home on **p4-5** when planning your VELUX STUDIO roof window installation.

Upgrade to VELUX INTEGRA® with a solar powered conversion kit. See p38 →

Benefits:

- Full 45° opening allows for stunning views.
- Ideal for loft conversions, allowing you to maximise the space and control with ease at the touch of a button.

NEW!

Roof pitch



Suitable for roof pitches between 15° and 65°.



VELUX INTEGRA® electric top-hung roof windows

All the benefits of top-hung and effortless remote-controlled electric operation together at last. It's perfect for creating a balcony-like feeling with spectacular panoramic views.

VELUX INTEGRA® electric top-hung roof windows

External frame size (nominal w x h) cm

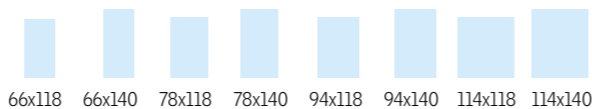

Code	Description	FK06	FK08	MK06	MK08	PK06	PK08	SK06	SK08
White polyurethane									
GPU 007021U U-value 1.3 W/m²K	Laminated inner, toughened outer pane.	£875	£921	£902	£957	£957	£1,053	£1,071	£1,112
GPU 006621U U-value 1.0 W/m²K	Triple glazed. Laminated inner, toughened outer pane. Anti-dew* and easy-to-clean coating.	£1,040	£1,086	£1,067	£1,122	£1,122	£1,218	£1,236	£1,277
Profile set for installations (EDN, EDJ, flashing kits)		FK06	MK06	PK06	SK06	FK08	MK08	PK08	SK08
Required for all recessed installations of GPU VELUX electric INTEGRA® top-hung roof windows		ZWP WK06 0000 £26				ZWP WK08 0000 £27			

- ▶ All roof windows have a lead time of 16 days.
- ▶ Not compatible with twin flashings, sloping and vertical combinations and insulated replacement flashings.
- ▶ Delivery time is in working days from receipt of orders placed before 4pm (UK) and 11.30am (NI).

*Anti-dew coating reduces number of hours external condensation is present.

Please note VELUX INTEGRA® electric top-hung roof windows are only compatible with manual or solar powered blinds.

All VELUX INTEGRA® roof windows are compatible with VELUX ACTIVE. See p15

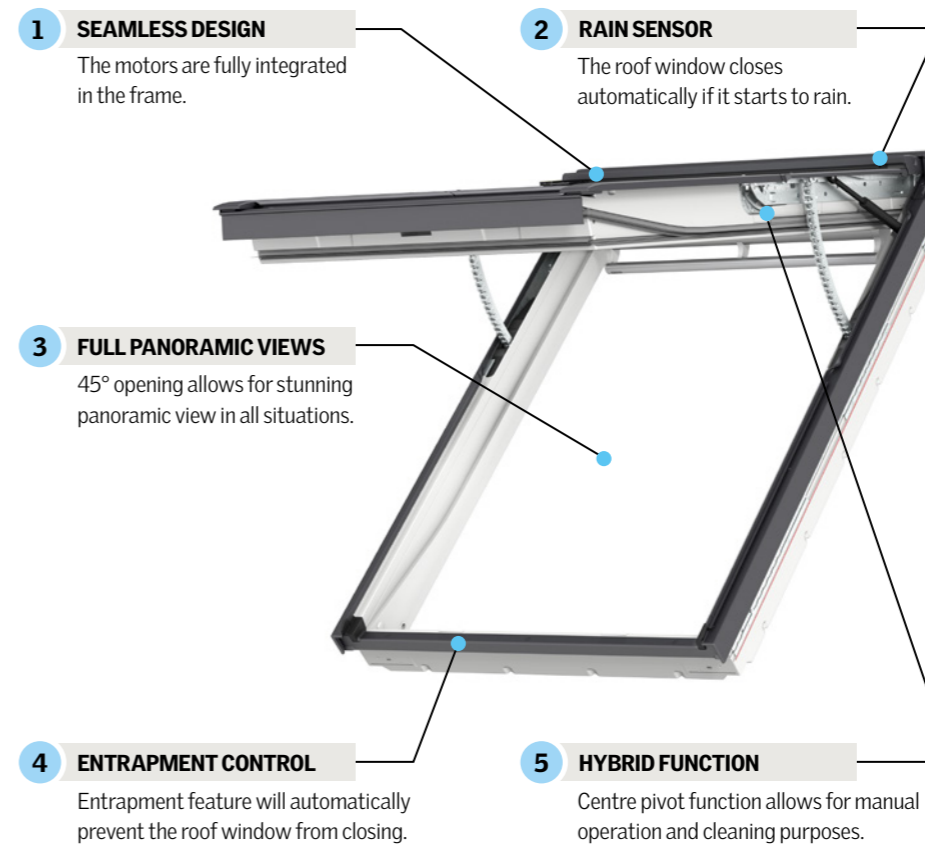

The perfect choice for loft conversions

Our VELUX INTEGRA® electric top-hung roof windows effortlessly transform your space, filling it with daylight. They are the ideal choice for maximising the space in your loft conversion. You can easily open the roof window using the convenient wall switch, or add VELUX ACTIVE for a healthier indoor climate that can be controlled via the smart phone app.

Benefits:

- Transforms from a roof window into a balcony in seconds.
- The top element opens outwards giving you extra headroom and beautiful panoramic views.

Roof pitch



Suitable for roof pitches between 35° and 53°.



VELUX CABRIO® balcony

Transforms from a roof window into a balcony in seconds

VELUX CABRIO® balcony



External frame size (nominal w x h) cm	78 x 252	166 x 252	94 x 252	198 x 252	114 x 252	238 x 252	
Code	MK19	MK19	PK19	PK19	SK19	SK19	
GDL SD0L001 U-value 1.2 W/m²K	VELUX CABRIO® balcony + flashings for slate up to 8mm thick.	£2,047	-	£2,201	-	£2,349	-
GDL SD0W001 U-value 1.2 W/m²K	VELUX CABRIO® balcony + flashings for tiles up to 120mm in profile.	£2,047	-	£2,201	-	£2,349	-
GDL SK0L222 U-value 1.2 W/m²K	VELUX CABRIO® balcony + 1 x GPL & 1 x GIL. Flashings for slate up to 8mm thick.	-	£3,819	-	£4,071	-	£4,383
GDL SK0W224 U-value 1.2 W/m²K	VELUX CABRIO® balcony + 1 x GPL & 1 x GIL. Flashings for tiles up to 120mm in profile.	-	£3,819	-	£4,071	-	£4,383

- ▶ All roof windows have a delivery time of 7 days.
- ▶ Delivery time is in working days from receipt of orders placed before 4pm (UK) and 11.30am (NI).

*Anti-dew coating reduces number of hours external condensation is present.

Other combinations available – please contact us for further information.



Give your loft conversion the wow factor it deserves

The top-hung upper section opens out, whilst the bottom section unfolds into a glazed balcony with side railings. The single balcony can easily be combined with additional top-hung and fixed sloping roof windows for even more daylight. Triple glazing is featured as standard, contributing to an energy-efficient installation, which includes a toughened outer and laminated inner pane for additional safety.

VELUX bundles – Completing your perfect project with ease

Achieving a hassle-free project means choosing the right materials and fittings. It's important to specify everything you need at the outset to get it right first time. If you have read through our daylight solution guide on [p4-5](#), you will have an idea of the size and quantity of roof windows you require for your space.



To make life easier, we've selected the optimal products for key projects, shown here as VELUX product bundles. You can order everything you need to optimise your installation with one single code, ensuring you choose the products that work best for the size and function of your room.

velux.co.uk/bundles

Multi roof window bundles for extensions

Creating the perfect balance between vertical glazing and the right number of roof windows will bring daylight deeper into your extension. Our multi roof window bundles for extensions will help you achieve this balance, along with giving you the easiest way to order **three** VELUX roof windows for your extension.

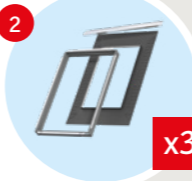
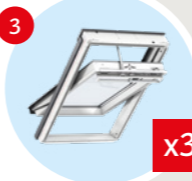
Add blinds to your multi product bundle. See p52 →

- 1  **FLASHINGS**
Marry the roof window to the roofing material. **x3**
- +
- 2  **INSTALLATION PRODUCTS**
Ensure a well-insulated and weathertight installation. **x3**
- +
- 3  **VELUX INTEGRA® ELECTRIC CENTRE-PIVOT WHITE POLYURETHANE ROOF WINDOWS**
Can be operated at the touch of a button to open automatically. White painted internal finish also available. **x3**
- OR
- 4  **MANUAL CENTRE-PIVOT WHITE POLYURETHANE ROOF WINDOWS**
Ideal for when the roof window is within reach or above furniture. White painted internal finish also available. **x3**



Glazed area each bundle provides in m ²	x3 1.41	x3 1.77	x3 2.16	x3 2.82
	78 x 98	78 x 118	78 x 140	114 x 118

Code	Description	MK04	MK06	MK08	SK06
VELUX INTEGRA® roof window bundles					
GGU S20W03	3 VELUX INTEGRA® electric white polyurethane roof windows with standard laminated glazing complete with insulated flashings for a tiled roof.	£2,259	£2,409	£2,556	£2,844
GGU S20L03	3 VELUX INTEGRA® electric white polyurethane roof windows with standard laminated glazing complete with insulated flashings for a slate roof.	£2,259	£2,409	£2,556	£2,844
GGL S20W03	3 VELUX INTEGRA® electric white painted roof windows with standard laminated glazing complete with insulated flashings for a tiled roof.	£2,049	£2,172	£2,292	£2,529
GGL S20L03	3 VELUX INTEGRA® electric white painted roof windows with standard laminated glazing complete with insulated flashings for a slate roof.	£2,049	£2,172	£2,292	£2,529
Manual roof window bundles					
GGU S10W03	3 centre-pivot white polyurethane roof windows with standard laminated glazing complete with insulated flashings for a tiled roof.	£1,329	£1,479	£1,626	£1,914
GGU S10L03	3 centre-pivot white polyurethane roof windows with standard laminated glazing complete with insulated flashings for a slate roof.	£1,329	£1,479	£1,626	£1,914
GGL S10W03	3 centre-pivot white painted roof windows with standard laminated glazing complete with insulated flashings for a tiled roof.	£1,119	£1,242	£1,362	£1,599
GGL S10L03	3 centre-pivot white painted roof windows with standard laminated glazing complete with insulated flashings for a slate roof.	£1,119	£1,242	£1,362	£1,599

- ▶ All bundles have a delivery time of 2 days.
- ▶ Delivery time is in working days from receipt of orders placed before 4pm (UK) and 11.30am (NI).

Multi roof window bundles for loft conversions

Installing VELUX roof windows in your loft conversion will add natural light and ventilation, turning a previously dark space into a comfortable, healthy room. Adding multiple roof windows maximises the amount of daylight in your loft. Our multi roof window loft bundles provide you with the ideal solution for ordering **three** VELUX roof windows for this space, with ease.

1

FLASHINGS
Marry the roof window to the roofing material.

x3

+

2

INSTALLATION PRODUCTS
Ensure a well-insulated and weathertight installation.

x3

+

3

TOP-HUNG WHITE PAINTED ROOF WINDOWS
Ideal for when the roof window is within reach, to make the most of your view. Maintenance-free white polyurethane internal finish also available.

x3

OR

4

CENTRE-PIVOT WHITE PAINTED ROOF WINDOWS
Ideal for when the roof window is set higher in the roof pitch or above furniture. Maintenance-free white polyurethane internal finish also available.

x3

Add blinds to your multi product bundle. See p52 →



Glazed area each bundle provides in m ²	x3	x3	x3	x3
	78 x 98	78 x 118	78 x 140	114 x 118
	1.41	1.77	2.16	2.82

Code	Description	MK04	MK06	MK08	SK06
Top-hung roof window bundles					
GPL S10W03	3 top-hung white painted roof windows with standard laminated glazing complete with insulated flashings for a tiled roof.	£1,440	£1,602	£1,764	£2,079
GPL S10L03	3 top-hung white painted roof windows with standard laminated glazing complete with insulated flashings for a slate roof.	£1,440	£1,602	£1,764	£2,079
GPU S10W03	3 top-hung white polyurethane roof windows with standard laminated glazing complete with insulated flashings for a tiled roof.	£1,695	£1,830	£2,016	£2,382
GPU S10L03	3 top-hung white polyurethane roof windows with standard laminated glazing complete with insulated flashings for a slate roof.	£1,695	£1,830	£2,016	£2,382
Centre-pivot roof window bundles					
GGL S10W03	3 centre-pivot white painted roof windows with standard laminated glazing complete with insulated flashings for a tiled roof.	£1,119	£1,242	£1,362	£1,599
GGL S10L03	3 centre-pivot white painted roof windows with standard laminated glazing complete with insulated flashings for a slate roof.	£1,119	£1,242	£1,362	£1,599
GGU S10W03	3 centre-pivot white polyurethane roof windows with standard laminated glazing complete with insulated flashings for a tiled roof.	£1,329	£1,479	£1,626	£1,914
GGU S10L03	3 centre-pivot white polyurethane roof windows with standard laminated glazing complete with insulated flashings for a slate roof.	£1,329	£1,479	£1,626	£1,914

- ▶ All bundles have a delivery time of 2 days.
- ▶ Delivery time is in working days from receipt of orders placed before 4pm (UK) and 11.30am (NI).

Single roof window bundles for loft conversions

Daylight is a big consideration in bedrooms. On the one hand you want a bright and airy room, but most people like a darker room for a good night's sleep, so this bundle combines a blackout blind with your choice of **one** roof window.

1

x1

FLASHING
Marries the roof window to the roofing material.

+

2

x1

INSTALLATION PRODUCT
Ensures a well-insulated and weathertight installation.

+

3

x1

TOP-HUNG WHITE PAINTED ROOF WINDOW
Ideal for when the roof window is within reach to create a feeling of extra space.

+

5

x1

BLACKOUT BLIND
Fabric offers complete blackout for darkness, ensuring a good night's sleep.

OR

4

x1

CENTRE-PIVOT WHITE PAINTED ROOF WINDOW
Ideal for when the roof window is set higher in the roof pitch or above furniture.

Blackout blind available in 2 colours: white or beige.

Code	Description	CK04	MK04	MK06	MK08	PK08	SK06
Top-hung roof window bundles							
GPL S10L04	Top-hung white painted roof window with laminated safety glazing, insulated flashing for slate and blackout blind in white.	£506	£552	£610	£670	£767	£789
GPL S10L06	Top-hung white painted roof window with laminated safety glazing, insulated flashing for slate and blackout blind in beige.	£506	£552	£610	£670	£767	£789
GPL S10W08	Top-hung white painted roof window with laminated safety glazing, insulated flashing for tiles and blackout blind in white.	£506	£552	£610	£670	£767	£789
GPL S10W06	Top-hung white painted roof window with laminated safety glazing, insulated flashing for tiles and blackout blind in beige.	£506	£552	£610	£670	£767	£789
Centre-pivot roof window bundles							
GGL S10L04	Centre-pivot, white painted roof window with laminated safety glazing, insulated flashing for slate and blackout blind in white.	£408	£445	£490	£536	£611	£629
GGL S10L06	Centre-pivot, white painted roof window with laminated safety glazing, insulated flashing for slate and blackout blind in beige.	£408	£445	£490	£536	£611	£629
GGL S10W07	Centre-pivot, white painted roof window with laminated safety glazing, insulated flashing for tiles and blackout blind in white.	£408	£445	£490	£536	£611	£629
GGL S10W05	Centre-pivot, white painted roof window with laminated safety glazing, insulated flashing for tiles and blackout blind in beige.	£408	£445	£490	£536	£611	£629

- ▶ All bundles have a delivery time of 2 days.
- ▶ Delivery time is in working days from receipt of orders placed before 4pm (UK) and 11.30am (NI).

Single roof window bundles for kitchens

Kitchens see their fair share of steam and moisture, which is why our single kitchen bundles feature **one** roof window with a moisture-resistant white polyurethane internal finish. Complete with flashing kit and installation products, these bundles include the most effective use of product for your kitchen space.

1 **FLASHING**
Marries the roof window to the roofing material.

2 **INSTALLATION PRODUCT**
Ensures a well-insulated and weathertight installation.

3 **VELUX INTEGRA® ELECTRIC CENTRE-PIVOT WHITE POLYURETHANE ROOF WINDOW**
Can be operated remotely at the touch of a button to open automatically.

OR

4 **CENTRE-PIVOT WHITE POLYURETHANE ROOF WINDOW**
Ideal for when the roof window is set higher in the roof pitch or above furniture.

5 **ELECTRIC PLEATED BLIND**
Open and close your blind at the touch of a button.

6 **MANUAL VENETIAN BLIND**
Stylish blind, perfect for roof windows within reach.

Make your home smarter with VELUX ACTIVE. See p15

Both pleated blind options available in 2 colours. Choose from: white or beige.

Code	Description	Size					
		55 x 98	78 x 98	78 x 118	78 x 140	94 x 140	114 x 118
		CK04	MK04	MK06	MK08	PK08	SK06
VELUX INTEGRA® electric centre-pivot roof window bundles							
GGU SDOL11201	VELUX INTEGRA® electric maintenance-free white polyurethane roof window with insulated flashing for slate and white electric pleated blind.	£851	£894	£948	£1,003	£1,093	£1,113
GGU SDOL11202	VELUX INTEGRA® electric maintenance-free white polyurethane roof window with insulated flashing for slate and beige electric pleated blind.	£851	£894	£948	£1,003	£1,093	£1,113
GGU SDOW11201	VELUX INTEGRA® electric maintenance-free white polyurethane roof window with insulated flashing for tiles and white electric pleated blind.	£851	£894	£948	£1,003	£1,093	£1,113
GGU SDOW11202	VELUX INTEGRA® electric maintenance-free white polyurethane roof window with insulated flashing for tiles and beige electric pleated blind.	£851	£894	£948	£1,003	£1,093	£1,113
Manual centre-pivot roof window bundles							
GGU SDOL11102	Centre-pivot maintenance-free white polyurethane window with insulated flashing for slate and white venetian blind.	£492	£537	£593	£650	£742	£764
GGU SDOW11102	Centre-pivot maintenance-free white polyurethane window with insulated flashing for tiles and white venetian blind.	£492	£537	£593	£650	£742	£764

- ▶ All bundles have a delivery time of 2 days.
- ▶ Delivery time is in working days from receipt of orders placed before 4pm (UK) and 11.30am (NI).

Single roof window bundles for living and dining rooms

It's where you spend quality time entertaining guests and relaxing, so make sure your living and dining space is welcoming and comfortable. This bundle provides you with the perfect solution for installing **one** roof window, including a pleated blind, letting you make the most of daylight whilst being able to close the blinds at night to ensure a cosy space for evenings in.

1 **FLASHING**
Marries the roof window to the roofing material.

2 **INSTALLATION PRODUCT**
Ensures a well-insulated and weathertight installation.

3 **VELUX INTEGRA® ELECTRIC CENTRE-PIVOT WHITE PAINTED ROOF WINDOW**
Can be operated remotely at the touch of a button to open automatically.

OR

4 **CENTRE-PIVOT WHITE PAINTED ROOF WINDOW**
Ideal for when the roof window is set higher in the roof pitch or above furniture.

5 **ELECTRIC PLEATED BLIND**
Open and close your blinds at the touch of a button.

6 **MANUAL PLEATED BLIND**
Stylish blinds, perfect for roof windows within reach.

Both pleated blind options available in 2 colours. Choose from: white or beige.

Code	Description	Size					
		55 x 98	78 x 98	78 x 118	78 x 140	94 x 140	114 x 118
		CK04	MK04	MK06	MK08	PK08	SK06
VELUX INTEGRA® electric centre-pivot roof window bundles							
GGL SDOL11201	VELUX INTEGRA® electric white painted roof window with insulated flashing for slate and white electric pleated blind.	£787	£824	£869	£915	£990	£1,008
GGL SDOL11202	VELUX INTEGRA® electric white painted roof window with insulated flashing for slate and beige electric pleated blind.	£787	£824	£869	£915	£990	£1,008
GGL SDOW11201	VELUX INTEGRA® electric white painted roof window with insulated flashing for tiles and white electric pleated blind.	£787	£824	£869	£915	£990	£1,008
GGL SDOW11202	VELUX INTEGRA electric white painted roof window with insulated flashing for tiles and beige electric pleated blind.	£787	£824	£869	£915	£990	£1,008
Manual centre-pivot roof window bundles							
GGL SDOL11103	Centre-pivot white painted roof window with insulated flashing for slate and white pleated blind.	£408	£445	£490	£536	£611	£629
GGL SDOL11104	Centre-pivot white painted roof window with insulated flashing for slate and beige pleated blind.	£408	£445	£490	£536	£611	£629
GGL SDOW11103	Centre-pivot white painted roof window with insulated flashing for tiles and white pleated blind.	£408	£445	£490	£536	£611	£629
GGL SDOW11104	Centre-pivot white painted roof window with insulated flashing for tiles and beige pleated blind.	£408	£445	£490	£536	£611	£629

- ▶ All bundles have a delivery time of 2 days.
- ▶ Delivery time is in working days from receipt of orders placed before 4pm (UK) and 11.30am (NI).

Our product features at a glance

Our highly engineered roof windows have the latest technology built-in. Our research and development teams are continuously refining products to improve performance.

The following features come as standard with all of our roof windows and are designed to make installation and operation easier, as well as ensuring our products look their best.

We are the only roof window manufacturer offering safety glazing as standard.

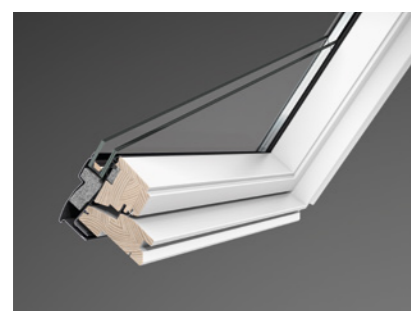

Safety glazing as standard in all roof windows.



High quality pivot hinges for smooth operation.



VELUX ThermoTechnology™ uses less energy and keeps your home warm.



Easy cleaning of the outside pane with built-in barrel bolt.

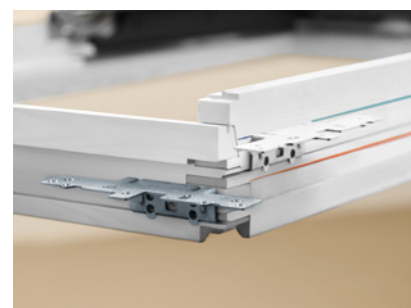

Simple red and blue line bracket system differentiates between standard and recessed installation.



Ventilation bar lets fresh air into your home even when roof window is closed.



Click-on covers make your installation easier, faster and safer.



Straight-forward blind installation with our patented mounting brackets.

Pick&Click!®

The finishing touch to suit your home

THREE INTERNAL FINISH OPTIONS

Lighter, brighter modern living spaces are more popular than ever. To ensure you have the means to make the most of your project, we offer three internal finish options. All finishes have the same high VELUX quality combined with:

- laminated safety glass as standard
- straightforward installation
- excellent value for money.

WHITE POLYURETHANE FINISH

- Wooden core encased in moisture-resistant white polyurethane. The first choice for humid rooms such as kitchens and bathrooms.
- No visible joints, so dirt can't accumulate in the corners.
- Maintenance-free, which is ideal for out-of-reach areas.
- Thermally moulded timber core delivers improved insulation.



WHITE PAINTED FINISH

- Painted before assembly for a flawless finish and outstanding durability.
- Bright white finish with discreet wood grain matches perfectly with modern interiors.
- Lower maintenance than pine finish roof windows.
- Highly UV resistant, water-based breathable paint to preserve a crisp, bright look.



PINE FINISH

- Matches perfectly with traditional interiors.
- Protective triple coat clear lacquer helps to preserve the timber of the window.



Benefits:

- Convenient, even with furniture placed beneath the roof window.
- Easy to open and close with the ventilation bar.

Roof pitch



15°-90°

Suitable for roof pitches between 15° and 90°.

Consider **VELUX INTEGRA®** range for out-of-reach roof windows. See p32-33



Benefits:

- Enjoy panoramic views.
- Rotates 180° for easy cleaning from the inside.
- Most sizes suitable for emergency escape purposes.

Roof pitch



15°-55°

Suitable for roof pitches between 15° and 55°. Also suitable for roof pitches between 55° and 75° with special springs. Please specify when ordering.

Consider **VELUX INTEGRA®** electric top-hung roof windows. See p18



VELUX centre-pivot roof windows

The classic choice

External frame size (nominal w x h) cm	55 x 78	55 x 98	55 x 118	78 x 98	66 x 118	78 x 118	78 x 140	134 x 98	94 x 140	114 x 118	94 x 160	134 x 140
Code	CK02	CK04	CK06	MK04	FK06	MK06	MK08	UK04	PK08	SK06	PK10	UK08
White polyurethane												
GGU 0070 U-value 1.3 W/m²K	Laminated inner, toughened outer pane.	£306	£323	£337	£351	£376	£397	£439	£506	£513	£527	£615
GGU 0068 U-value 1.1 W/m²K	Triple glazed. Laminated inner, toughened outer pane. Rain noise reduction.	£391	£408	£422	£436	£461	£482	£524	£591	£598	£612	£700
GGU 0066 U-value 1.0 W/m²K	Triple glazed. Laminated inner, toughened outer pane. Anti-dew* and easy-to-clean coating.	£471	£488	£502	£516	£541	£562	£604	£671	£678	£692	£780
GGU 0062 U-value 0.92 W/m²K	Triple glazed. Laminated inner, toughened outer with anti-dew* coating. Further enhanced noise reduction.	£556	£573	£587	£601	£626	£647	£689	-	£763	£777	£791
GGU 0070Q U-value 1.3 W/m²K	Laminated inner, toughened outer pane. Enhanced security.	£391	£408	-	£436	£461	£482	£524	£591	£598	£612	£700
White painted												
GGL 2070 U-value 1.3 W/m²K	Laminated inner, toughened outer pane.	£244	£259	£270	£281	£301	£318	£351	£405	£410	£422	£492
GGL 2068 U-value 1.1 W/m²K	Triple glazed. Laminated inner, toughened outer pane. Rain noise reduction.	£329	£344	£355	£366	£386	£403	£436	£490	£495	£507	£577
GGL 2066 U-value 1.0 W/m²K	Triple glazed. Laminated inner, toughened outer pane. Anti-dew* and easy-to-clean coating.	£409	£424	£435	£446	£466	£483	£516	£570	£575	£587	£657
GGL 2062 U-value 0.92 W/m²K	Triple glazed. Laminated inner, toughened outer with anti-dew* coating. Further enhanced noise reduction.	£494	£509	£520	£531	£551	£568	£601	-	£660	£672	£683
GGL 2070Q U-value 1.3 W/m²K	Laminated inner, toughened outer pane. Enhanced security.	£360	£378	-	£366	£386	£439	£436	£490	£495	£505	£577

- ▶ All roof windows have a delivery time of 2 days except '62' and '70Q' pane windows which are 7 days.
- ▶ Delivery time is in working days from receipt of orders placed before 4pm (UK) and 11.30am (NI).

*Anti-dew coating reduces number of hours external condensation is present.

VELUX top-hung roof windows

A great choice for loft conversions

External frame size (nominal w x h) cm	55 x 98	55 x 118	78 x 98	66 x 118	78 x 118	78 x 140	134 x 98	94 x 140	114 x 118	94 x 160	134 x 140
Code	CK04	CK06▲	MK04▲	FK06▲	MK06▲	MK08▲	UK04▲	PK08▲	SK06▲	PK10▲	UK08▲
White polyurethane											
GPU 0070 U-value 1.3 W/m²K	Laminated inner, toughened outer pane.	£419	£437	£473	£487	£514	£569	-	£665	£683	£701
GPU 0068 U-value 1.1 W/m²K	Triple glazed. Laminated inner, toughened outer pane. Rain noise reduction.	£504	£522	£540	£572	£599	£654	-	£750	£768	£882
GPU 0066 U-value 1.0 W/m²K	Triple glazed. Laminated inner, toughened outer pane. Anti-dew* and easy-to-clean coating.	£584	£602	£620	£652	£679	£734	-	£830	£848	£962
GPU 0062 U-value 0.96 W/m²K	Triple glazed. Laminated inner, toughened outer with anti-dew* coating. Further enhanced noise reduction.	£669	£687	£705	£737	£764	£819	-	£915	£933	£951
White painted											
GPL 2070 U-value 1.3 W/m²K	Laminated inner, toughened outer pane.	£357	£372	£388	£415	£438	£485	£558	£566	£582	£679
GPL 2068 U-value 1.1 W/m²K	Triple glazed. Laminated inner, toughened outer pane. Rain noise reduction.	£442	£457	£473	£500	£523	£570	£643	£651	£667	£764
GPL 2066 U-value 1.0 W/m²K	Triple glazed. Laminated inner, toughened outer pane. Anti-dew* and easy-to-clean coating.	£522	£537	£553	£580	£603	£650	£723	£731	£747	£844

- ▲ Sizes suitable for emergency escape requirements.
- ▶ All roof windows have a delivery time of 2 days except GPU 0066, GPU 0062 and GPL 2062 which are 7 days.
- ▶ Delivery time is in working days from receipt of orders placed before 4pm (UK) and 11.30am (NI).

*Anti-dew coating reduces number of hours external condensation is present.

Opening options

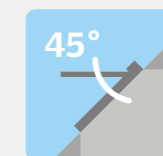

45° OPENINGS
GPU and GPL roof windows open to any position up to 45°.



EMERGENCY ESCAPE
Due to the unrestricted opening area, a large selection of roof windows are suitable for emergency escape purposes.

Benefits:

- VELUX INTEGRA® roof windows have rain sensors meaning they automatically close when it rains.
- Ideal for out-of-reach areas.
- VELUX INTEGRA® roof windows offer control at your fingertips and provide fresh air, better indoor comfort and home security.

Roof pitch

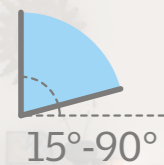

Suitable for roof pitches between 15° and 90°.



All VELUX INTEGRA® roof windows are compatible with VELUX ACTIVE. See p15



Benefits:

- No need for a mains power supply.
- VELUX INTEGRA® roof windows have rain sensors meaning they automatically close when it rains.
- Ideal for out-of-reach areas.
- VELUX INTEGRA® roof windows offer control at your fingertips and provide fresh air, better indoor comfort and home security.

Roof pitch

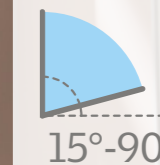

Suitable for roof pitches between 15° and 90°.

VELUX INTEGRA® electric centre-pivot roof windows

The ideal solution for out-of-reach areas

External frame size (nominal w x h) cm		55 x 78	55 x 98	55 x 118	78 x 98	66 x 118	78 x 118	78 x 140	134 x 98	94 x 140	114 x 118	94 x 160	134 x 140
Code	Glazing	CK02	CK04	CK06	MK04	FK06	MK06	MK08	UK04	PK08	SK06	PK10	UK08
VELUX INTEGRA® electric													
White polyurethane													
GGU 007021U U-value 1.3 W/m²K	Laminated inner, toughened outer pane.	£616	£633	£647	£661	£686	£707	£749	£816	£823	£837	£851	£925
*GGU 006821U U-value 1.1 W/m²K	Triple glazed. Laminated inner, toughened outer pane. Easy-to-clean coating, Rain noise reduction.	£701	£718	£732	£746	£771	£792	£834	£901	£908	£922	£936	£1,010
GGU 006621U U-value 1.0 W/m²K	Triple glazed. Laminated inner, toughened outer pane. Anti-dew** and easy-to-clean coating.	£781	£798	£812	£826	£851	£872	£914	£981	£988	£1,002	£1,016	£1,090
White painted													
GGL 207021U U-value 1.3 W/m²K	Laminated inner, toughened outer pane.	£554	£569	£580	£591	£611	£628	£661	£715	£720	£732	£743	£802
*GGL 206821U U-value 1.1 W/m²K	Triple glazed. Laminated inner, toughened outer pane. Rain noise reduction.	£639	£654	£665	£676	£696	£713	£746	£800	£805	£817	£828	£887
GGL 206621U U-value 1.0 W/m²K	Triple glazed. Laminated inner, toughened outer pane. Anti-dew** and easy-to-clean coating.	£719	£734	£745	£756	£776	£793	£826	£880	£885	£897	£908	£967

- ▶ All roof windows have a delivery time of 2 days except '66' pane windows which are 7-11 days.
- ▶ Delivery time is in working days from receipt of orders placed before 4pm (UK) and 11.30am (NI).

*GGU 006821U and GGL 206821U available May 2020. **Anti-dew coating reduces number of hours external condensation is present.



Electric

- Operate your roof windows with a convenient wall switch.
- Fully integrated motor which runs almost without a sound.

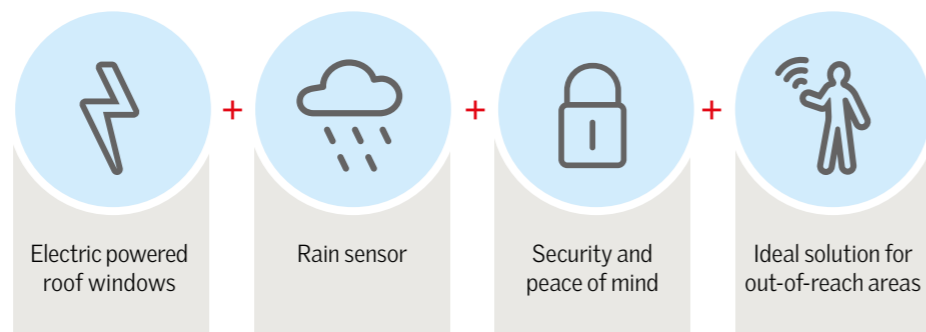

VELUX INTEGRA® solar powered centre-pivot roof windows

No need for a mains power supply

External frame size (nominal w x h) cm		55 x 78	55 x 98	55 x 118	78 x 98	66 x 118	78 x 118	78 x 140	134 x 98	94 x 140	114 x 118	94 x 160	134 x 140
Code	Glazing	CK02	CK04	CK06	MK04	FK06	MK06	MK08	UK04	PK08	SK06	PK10	UK08
VELUX INTEGRA® solar powered													
White polyurethane													
GGU 007030 U-value 1.3 W/m²K	Laminated inner, toughened outer pane.	£656	£673	£687	£701	£726	£747	£789	£856	£863	£877	£891	£965
*GGU 006830 U-value 1.1 W/m²K	Triple glazed. Laminated inner, toughened outer pane. Rain noise reduction.	£741	£758	£772	£786	£811	£832	£874	£941	-	£962	£976	£1,050
GGU 006630 U-value 1.0 W/m²K	Triple glazed. Laminated inner, toughened outer pane. Anti-dew** and easy-to-clean coating.	£821	£838	£852	£866	£891	£912	£954	£1,021	£1,028	£1,042	£1,056	£1,130
White painted													
GGL 207030 U-value 1.3 W/m²K	Laminated inner, toughened outer pane.	£594	£609	£620	£631	£651	£668	£701	£755	£760	£772	£783	£842
*GGL 206830 U-value 1.1 W/m²K	Triple glazed. Laminated inner, toughened outer pane. Rain noise reduction.	£679	£694	£705	£716	£736	£753	£786	£840	-	£857	£868	£927
GGL 206630 U-value 1.0 W/m²K	Triple glazed. Laminated inner, toughened outer pane. Anti-dew** and easy-to-clean coating.	£759	£774	£785	£796	£816	£833	£866	£920	£925	£937	£948	£1,007

- ▶ All roof windows have a delivery time of 2 days except '66' pane windows which are 7 days.
- ▶ Delivery time is in working days from receipt of orders placed before 4pm (UK) and 11.30am (NI).

*GGU 006830 and GGL 206830 available May 2020. **Anti-dew coating reduces number of hours external condensation is present.



Solar powered

- All the same features as VELUX INTEGRA® electric roof windows, but powered by the sun.
- PV solar cell on external window frame requires some exposure to sunlight.

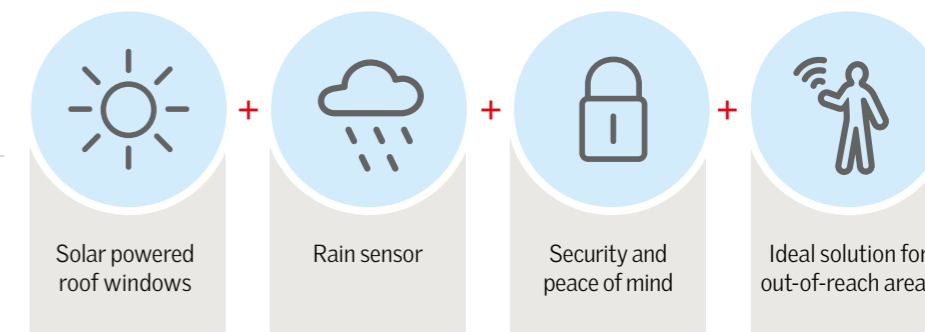

Benefits:

- Adding an additional fixed element underneath a sloping roof window will bring in even more daylight.
- Create the perfect combination for your space with a wide range of size and combination options (see p66 for available sizes).

Roof pitch

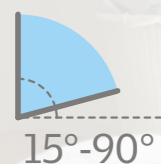

Suitable for roof pitches between 15° and 90°.



For more advice on how to select your roof windows visit: velux.co.uk/onlinebrochure

Sloping and fixed combinations

Give your home its own unique character

Multiple VELUX roof windows create gorgeous, light-filled rooms. By combining VELUX roof windows, you can create panoramic views and bring in twice the daylight. If the pitch of your roof continues to the floor, you can extend your VELUX roof window by installing an additional window element, GIU (white polyurethane) or GIL (white painted) below. These bottom elements have a fixed sash that cannot be opened.

Sloped additional elements

External frame size (nominal w x h) cm

Code	Glazing	MK34	PK34
White polyurethane – fixed			
For a maintenance-free white polyurethane finish additional roof window elements GIU can be installed below VELUX roof windows GGU and GPU.			
GIU 0070 U-value 1.3 W/m²K	Laminated inner, toughened outer pane.	£444	£513
GIU 0066 U-value 1.0 W/m²K	Triple glazed. Laminated inner, toughened outer pane. Anti-dew* and easy-to-clean coating.	£609	£678
White painted – fixed			
For a white painted combination additional roof window elements GIL can be installed below VELUX roof windows GGL and GPL.			
GIL 2070 U-value 1.3 W/m²K	Laminated inner, toughened outer pane.	£400	£462
GIL 2066 U-value 1.0 W/m²K	Triple glazed. Laminated inner, toughened outer pane. Anti-dew* and easy-to-clean coating.	£565	£627

*Anti-dew coating reduces number of hours external condensation is present.

Flashings – single

External frame size (nominal w x h) cm

Code	Description	MK04	MK06	MK08	PK08	PK10
EDL S0121	Single installation for slate up to 8mm thick.	£105	£108	£113	£121	£123
EDW S0121	Single installation for tiles up to 120mm in profile.	£105	£108	£113	£121	£123

- ▶ All roof windows and flashings have a delivery time of 7 days.
- ▶ Delivery time is in working days from receipt of orders placed before 4pm (UK) and 11.30am (NI).



Featured: VIU MK35 0066



Featured: VFA MK35 2070

Benefit:

- Ideal for one and a half-storey properties.

Roof pitch



Suitable for roof pitches between 15° and 55°.

Sloping and vertical combinations

Combine sloping and vertical white polyurethane or white painted roof windows to expand your view and increase daylight. Our VFA and VFB side-hung vertical elements for tilt-and-turn opening come with opening restrictor for enhanced safety.

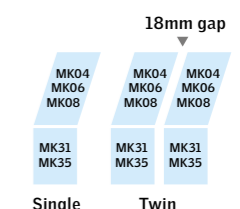

Vertical elements

External frame size (nominal w x h) cm

Code	Glazing	MK31	MK35
White polyurethane – fixed			
VIU 0070 U-value 1.3 W/m²K	Laminated inner, toughened outer pane.	£415	£450
VIU 0066 U-value 1.0 W/m²K	Triple glazed. Laminated inner, toughened outer pane. Anti-dew* and easy-to-clean coating.	£580	£615
White painted – bottom-hung opening inwards			
VFE 2070 U-value 1.3 W/m²K	Laminated inner, toughened outer pane.	£415	£450
VFE 2066 U-value 1.0 W/m²K	Triple glazed. Laminated inner, toughened outer pane. Anti-dew* and easy-to-clean coating.	£580	£615
White painted – tilt-and-turn			
VFA 2070 U-value 1.3 W/m²K	Left-hung. Laminated inner, toughened outer pane.	-	£450
VFB 2070 U-value 1.3 W/m²K	Right-hung. Laminated inner, toughened outer pane.	-	£450

*Anti-dew coating reduces number of hours external condensation is present.

Flashings

External frame size (nominal w x h) cm

Code	Description	MK04	MK06	MK08
EFL 0012	Single installation, for slate up to 8mm thick.	£104	£109	£116
EFW 0012	Single installation, for tiles up to 120mm in profile.	£104	£109	£116
EFL 0022B	Twin installation, for slate up to 8mm thick.	£208	£218	£233
EFW 0022B	Twin installation, for tiles up to 120mm in profile.	£208	£218	£233

Internal trimmer – white

Code	Description			
EBY W10 2100	18mm gap adjustable trimmer (x1 for twin installation, x2 for triple installation). White painted.	-	-	£384

- ▶ All roof windows, single flashing and trimmers have a delivery time between 2-7 days.
- ▶ Delivery time is in working days from receipt of orders placed before 4pm (UK) and 11.30am (NI).

What does a conservation package include?

- Roof window with pre-fitted glazing bar.
- Laminated safety glazing as standard.
- Insulation collar and underfelt collar provided for a weathertight and energy efficient installation.



Roof pitch

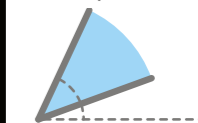

20°-65°

Suitable for roof pitches between 20° and 65°.

VELUX conservation roof windows

For traditional buildings

When planning dictates that a window of traditional external appearance is required, conservation roof windows should be considered. All of our conservation roof windows have the same technical features of a VELUX roof window but in a traditional black conservation style.

Please visit velux.co.uk/onlinebrochure for information on how to create your own grey conservation package.

- Available in either centre-pivot or top-hung.
- Black external profiles and glazing bar.
- RAL colour 9005.
- Recessed installation for slate and tiled roofs.
- Top-hung roof windows listed below are suitable for emergency escape.
- Other sizes and glazing options available – contact us for further information.

Conservation roof windows

External frame size (nominal w x h) cm

Code	Description	55 x 98	55 x 118	66 x 118	78 x 118	78 x 140	134 x 98
		CK04	CK06	FK06	MK06	MK08	UK04
Centre-pivot white painted							
GGL SD5N2 U-value 1.3 W/m²K	GGL 2570 roof window + EDN recessed flashing for slate up to 8mm thick (min 20° roof pitch).	£484	£502	£555	£584	£629	£732
GGL SD5P2 U-value 1.3 W/m²K	GGL 2570 roof window + EDP flashing for plain tiles up to 14mm thick (min 25° roof pitch).	£426	£442	£491	£517	£558	£652
GGL SD5W2 U-value 1.3 W/m²K	GGL 2570 roof window + EDW flashing for tiles up to 120mm in profile (min 15° roof pitch).	£426	£442	£491	£517	£558	£652
GGL SD5J2 U-value 1.3 W/m²K	GGL 2570 roof window + EDJ recessed flashing for tiles up to 90mm in profile (min 20° roof pitch).	£484	£502	£555	£584	£629	£732
Top-hung white painted. For roof pitches of 55°-75°, please specify special springs when ordering.							
GPL SD5N2 U-value 1.3 W/m²K	GPL 2570 roof window + EDN recessed flashing for slate up to 8mm thick (min 20° roof pitch).	-	-	-	-	£763	-
GPL SD5P2 U-value 1.3 W/m²K	GPL 2570 roof window + EDP flashing for plain tiles up to 14mm thick (min 25° roof pitch).	-	-	-	-	£692	-
GPL SD5W2 U-value 1.3 W/m²K	GPL 2570 roof window + EDW flashing for tiles up to 120mm in profile (min 15° roof pitch).	-	-	-	-	£692	-
GPL SD5J2 U-value 1.3 W/m²K	GPL 2570 roof window + EDJ recessed flashing for tiles up to 90mm in profile (min 20° roof pitch).	-	-	-	-	£763	-

- ▶ All roof windows have a delivery time of 2 days.
- ▶ Delivery time is in working days from receipt of orders placed before 4pm (UK) and 11.30am (NI).

Rooflights for uninhabited spaces

Rooflights

- Frame and integrated flashing made of maintenance-free polyurethane.
- Operated using a handle with three ventilation positions.
- Extruded aluminium sash which can be hinged on both sides, opening to an angle of 90°.
- Opening restrictor that engages at 90° only.
- Black internal and external finish.

Uninhabited spaces

Our rooflights are designed in such a way that you have the opportunity to bring light into uninhabited spaces. It is not advisable to use these rooflights in habitable rooms due to their thermal performance.



Rooflights for uninhabited spaces

External frame size (nominal w x h) cm

Code	Description	54 x 83	46 x 61
GVT 103 0059Z U-value 3.1 W/m²K	Side-hung outward-opening rooflight.	£192	-
GVK 0000Z U-value 5.1 W/m²K	Side-hung outward-opening rooflight.	-	£141

- ▶ All rooflights have a delivery time of 2 days.
- ▶ Delivery time is in working days from receipt of orders placed before 4pm (UK) and 11.30am (NI).



For replacement glazing options please visit: velux.co.uk/onlinebrochure

Replacing and upgrading roof windows

Let in more daylight, create more comfort and increase energy efficiency

Quick and simple

- Minimal disruption as roof windows are replaced in the existing aperture.
- Replacement installation can typically be finished in a day.
- Work can usually be carried out from the inside.

Always improving

- Improved thermal performance and sound reduction for greater comfort.
- Larger glazing areas allowing more daylight in.
- Upgrade to a white finish or VELUX INTEGRA® electric or solar powered roof window.
- Add a solar powered conversion kit to your existing manual roof window for automation.

Save time and money with VELUX replacement flashings

- EL and EW single replacement flashings allow old roof windows manufactured before April 2001 to be replaced without disturbing the interior finish of the room.

Replacement roof window flashings

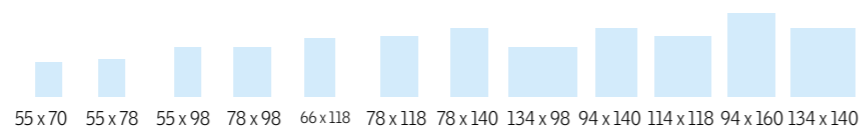

Code	Description	CK01	CK02	CK04	MK04	FK06	MK06	MK08	UK04	PK08	SK06	PK10	UK08
For replacing single roof windows installed before April 2001. (Window size to be replaced shown in brackets.)		(9)	(102)	(6)	(304)	(206)	(306)	(308)	(804)	(408)	(606)	(410)	(808)
EL 0000	For slate up to 8mm thick.	£62	-	£64	£72	-	£75	£80	£95	£90	£89	£93	£102
EW 0000	For tiles up to 120mm thick.	£62	-	£64	£72	-	£75	£80	£95	£90	£89	£93	£102
ELX 0000	Adaptor flashing for combinations. Also for use in conjunction with EDL & EDW.	£55	-	£56	£63	-	£66	£71	£83	£79	£78	£81	£89

- ▶ EL 0000 and EW 0000 have a delivery time of 2 days.
- ▶ All other replacement flashings have a delivery time of 7 days.
- ▶ Delivery time is in working days from receipt of orders placed before 4pm (UK) and 11.30am (NI).

Solar powered conversion kits

Code	Description	Price
KSX 100	Conversion kit to upgrade to full VELUX INTEGRA® solar powered functionality of GGU or GGL centre-pivot roof windows manufactured between April 1986 and January 2014 (includes rain sensor). Not compatible with M27, P25 and 425.	£235
KSX 100K	Conversion kit to upgrade to full VELUX INTEGRA® solar powered functionality of GGU or GGL centre-pivot roof windows manufactured after February 2014 (includes rain sensor). Not compatible with CK01, CK02, MK27, PK25 and SK01.	£235

- ▶ All conversion kits have a delivery time of 2 days.

Installation products

Building regulations relating to insulation and air-tightness of roof window installations have become more stringent. We have not only developed a range of installation products to help make it quick and easy for you to be compliant, but also offers increased energy efficiency.

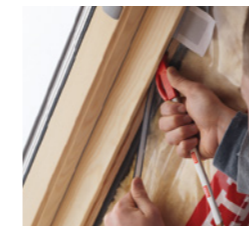

Vapour barrier – BBX

- Helps prevent condensation from forming in the roof structure.
- A fully welded rubber gasket with a double pressure seal guarantees speedy installation and a vapour and air tight solution.
- Reinforced corners for extra security against perforation.



Insulation collar – BDX

- Insulates around the roof window frame, reducing heat loss and eliminating cold bridges.
- Supplied with BFX underfelt collar.
- Click fittings ensure fast and accurate assembly.



Underfelt collar – BFX

- Ensures a weathertight seal between the roof window and the roof.
- Made from diffusion open material to minimise risk of condensation.
- Comes with transverse drainage gutter to lead water away from the head of the roof window if a tile or slate is broken above the window.

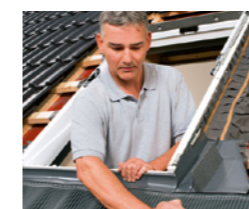

Flashing

- Marries the roof window to the roofing material and ensures a weathertight seal.
- Standard VELUX flashings are compatible with VELUX installation products.

Installation products

Code	Description	CK02	CK04	CK06	MK04	FK06	MK06	MK08	UK04	PK08	SK06	PK10	UK08
BBX 0000	Vapour barrier.	£22	£23	£24	£24	£24	£25	£27	£28	£28	£28	£29	£30
BDX 2000	Insulation collar for EDL / EDW / EDP (also includes BFX underfelt collar).	£30	£31	£33	£34	£34	£35	£37	£39	£38	£39	£40	£42
BDX 2011	Insulation collar for EBL / EBW / EBP twin installations (18mm gap).	£61	£63	£65	£68	£68	£71	£74	£78	£77	£78	£80	£84
BDX 2011E	Insulation collar for EKL / EKW and EKP coupled installations (100mm gap).	£61	£63	£65	£68	£68	£71	£74	£78	£77	£78	£80	£84
BFX 1000	Underfelt collar and transverse drainage gutter.	£21	£22	£23	£23	£23	£24	£26	£27	£27	£27	£28	£29

- ▶ All installation products have a delivery time of 2 days.
- ▶ Delivery time is in working days from receipt of orders placed before 4pm (UK) and 11.30am (NI).



Without



With

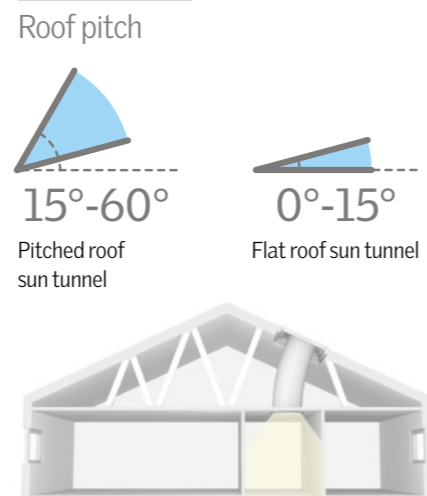

VELUX sun tunnels

Natural daylight where you never thought it could be achieved. Ideal for windowless bathrooms, hallways and walk-in wardrobes.

Rigid sun tunnels for pitched roof

- Rigid tunnels are recommended for maximum daylight.
- Recommended tunnel length 0.9-6m.
- 1.7m tunnel supplied (ZTR extensions are available).
- Available in 10 and 14 inch diameter.

Flexible sun tunnels for pitched roof

- Flexible sun tunnels should be used where a rigid tunnel is not suitable.
- Recommended tunnel length 1.5m.
- 2m tunnel supplied.

Flat roof sun tunnels

- Available in flexible.
- Supplied with PVC kerb and polycarbonate dome.
- Recommended tunnel length 0.2 – 0.9m.
- 0.9m tunnel supplied.

Sun tunnels

External frame size (nominal w x h) cm

Code	Description	10"	14"
Rigid sun tunnels			
TWR OK10 2010	10" diameter rigid tunnel for tiles up to 120mm in profile.	£290	-
TLR OK10 2010	10" diameter rigid tunnel for slate up to 8mm thick.	£290	-
TWR OK14 2010	14" diameter rigid tunnel for tiles up to 120mm in profile.	-	£333
TLR OK14 2010	14" diameter rigid tunnel for slate up to 8mm thick.	-	£333
Flexible sun tunnels			
TWF OK14 2010	14" diameter flexible tunnel for tiles up to 120mm in profile.	-	£290
TLF OK14 2010	14" diameter flexible tunnel for slate up to 8mm thick.	-	£290
Flat roof sun tunnels			
TCF OK14 1010	14" diameter flat roof flexible tunnel with polycarbonate cover.	-	£350
Accessories			
ZTR OK10 0062	600mm extension section for 10" rigid diameter sun tunnel.	£62	-
ZTR OK14 0062	600mm extension section for 14" rigid diameter sun tunnel.	-	£62
ZTR OK14 0124	1,200mm extension section for 14" rigid diameter sun tunnel.	-	£119
ZTL 014	Low-energy light kit for 10" and 14", fits inside tunnel, requires mains connection. Bulb supplied.	-	£79

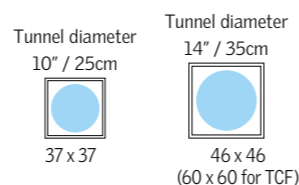

- ▶ All sun tunnels and accessories have a delivery time of 2 days.
- ▶ Delivery time is in working days from receipt of orders placed before 4pm (UK) and 11.30am (NI).

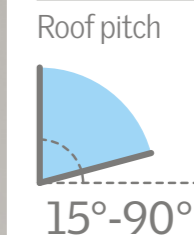

Suitable for roof pitches between 15° and 90°.

Smoke ventilation systems

Smoke ventilation system for pitched roofs

Code	Description	SK06	UK08
External frame size (nominal w x h) cm: 114 x 118, 134 x 140			
Packages include: Single electrically operated GGU white polyurethane roof window with laminated inner pane for additional safety, 1 smoke sensor, 1 break glass point, 1 wall control (KFX 210) and suitable flashing. Additional smoke sensors and break glass units can be purchased separately.			
GGU SD0L140 U-value 1.3 W/m²K	GGU 0070 roof window + flashings for slate up to 8mm thick.	£1,666	£1,765
GGU SD0W140 U-value 1.3 W/m²K	GGU 0070 roof window + flashings for tiles up to 120mm in profile.	£1,666	£1,765
KFD 0000	Wind deflector (for compliance to aerodynamic smoke ventilation requirements).	£491	£553

Available for 1m² (SK06 size) or 1.5m² (UK08 size) of smoke-free ventilation area.

- For geometric smoke ventilation, our systems are tested and certified to EN ISO 12101-2 for roof pitches between 15-90°.
- For aerodynamic smoke ventilation, our systems are tested and certified to EN ISO 12101-2 for roof pitches between 15-60°.
- Comes with laminated inner pane for additional safety.
- System can be upgraded to comply with aerodynamic smoke ventilation requirements by the inclusion of the optional KFD external wind deflector.
- Other sizes available, contact us for further information.



Flat roof smoke ventilation system

Innovative solution for a flat roof where smoke ventilation is required. Available for 0.88m² (100x100cm) or 1.30m² (120 x120cm) of smoke-free ventilation area.

- Double-glazed window with protective polycarbonate cover.
- AA fire rated.
- Tested and certified to EN ISO 12101-2.
- Smoke sensors, control systems and break glass units to be purchased separately.

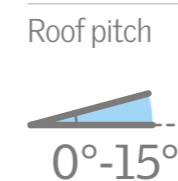

When ordering your flat roof window, please ensure you order a base unit (CSP) and compatible dome.

Flat roof smoke ventilation

Code	Description	100100	120120
External frame size (nominal w x h) cm: 118 x 118, 138 x 138			
Structural opening size (nominal w x h) cm: 100 x 100, 120 x 120			
CSP 1073Q	Smoke vent base. Compatible with polycarbonate dome top covers only.	£1,608	£1,962
ISD 0010	Clear polycarbonate dome.	£266	£346
ISD 0110	Obscure polycarbonate dome.	£266	£346
Accessories			
KFC 210	Control system for operation of 4 pitched roof windows or 1 flat roof window.		£611
KFC 220	Control system for operation of 8 pitched roof windows or 2 flat roof windows.		£791
KFA 100	Smoke sensor.		£75
KFK 100	Break glass unit.		£74

- ▶ All smoke ventilation products have a delivery time of 2 days except KFD 0000 which are 7 days.
- ▶ All roof windows have a delivery time of 2 days.
- ▶ Delivery time is in working days from receipt of orders placed before 4pm (UK) and 11.30am (NI).

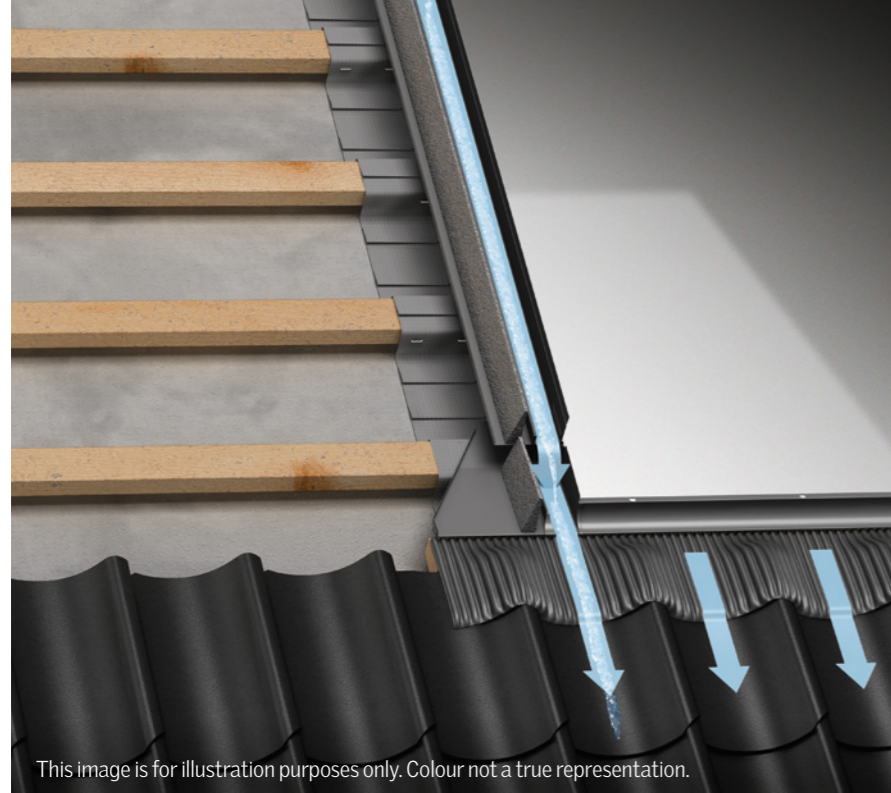

This image is for illustration purposes only. Colour not a true representation.

Compatibility

To find out more about the compatibility of roofing materials, flashings and different installations (such as thatch and interlocking slate tile), please go to velux.co.uk/flashings

Opening sizes depend on the flashings used. Instructions available online.

Flashings

We provide a range of flashing options to suit your roofing material. The information below will help you to select the most appropriate flashings for your installation.

EDN / EKN



20°-90°

- Recessed flashings for installing roof windows into slate up to 8mm thick.
- EDN 2000 Includes BDx 2000F insulation package as standard.
- Not for interlocking slate.

EDJ / EKJ



20°-90°

- Recessed flashings for installing roof windows into flat or profiled roofing material up to 90mm in profile.
- EDJ 2000 Includes BDx 2000F insulation package as standard.

EDT

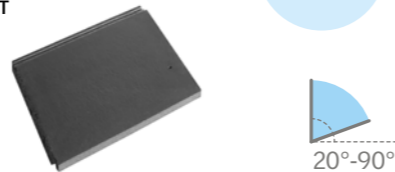

20°-90°

- Flashing for installing roof windows into flat tiles between 15mm-40mm in thickness.
- Perfectly designed for flat tiles providing a neater finish.

Available Summer 2020

EDL / EBL / EKL



15°-90°

- Flashings for installing roof windows into slate up to 8mm thick.
- Not for interlocking slate. See EDW for details.

EDW / EBW / EKW



15°-90°

- Flashings for installing roof windows into flat or profiled roofing material up to 120mm in profile.
- Also for interlocking slate, thatch and profiled sheeting.
- Our EDW flashing suits virtually every installation and supersedes EDZ as our standard tile flashing.

EDP / EBP / EKP

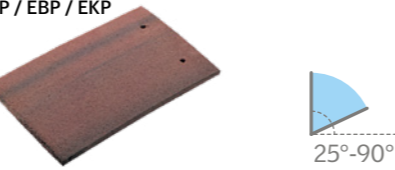

25°-90°

- Flashings for installing roof windows into plain tiles (max length 300mm).
- Maximum thickness of 14mm.

Recessed and standard flashings



Featured: EDJ recessed tile installation.

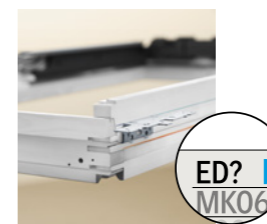

Featured: EDW standard tile installation.

Recessed flashings

Recessed flashings provide a sleek and streamlined finish as the roof window is installed deeper into the roof structure (see image above), meaning that less of the roof window protrudes above the roofline. We recommend BDx insulation collar and BFX underfelt collar, included in EDN and EDJ 2000, for optimum energy efficiency.

Recessed installation height – install the brackets at the sides of the roof window frame, at the blue line level.

Standard roof window flashings

We provide a range of flashing options to suit your roofing material. The table below will help you to select the most appropriate flashings.

Standard installation height – install the brackets at the top and the bottom of the window frame, at the red line level.

EDN, EDJ, EDL, EDW and EDT 2000 variants come with installation products included.

Recessed flashings

External frame size (nominal w x h) cm	55 x 78	55 x 98	55 x 118	78 x 98	66 x 118	78 x 118	78 x 140	134 x 98	94 x 140	114 x 118	94 x 160	134 x 140
Code	CK02	CK04	CK06	MK04	FK06	MK06	MK08	UK04	PK08	SK06	PK10	UK08
Recessed flashings including installation products (BDx 2000F)												
EDN 2000	For recessed installation in slate up to 8mm thick. Roof pitch 20°-90°.	£132	£136	£148	£151	£151	£157	£167	£189	£181	£181	£203
EDJ 2000	For recessed installation in tiles up to 90mm in profile. Roof pitch 20°-90°.	£132	£136	£142	£151	£151	£157	£167	£189	£181	£181	£203
Recessed flashings not including installation products												
EDN 0000	For recessed installation in slate up to 8mm thick. Roof pitch 20°-90°.	£82	£84	£88	£95	£95	£99	£106	£125	£118	£117	£134
EDJ 0000	For recessed installation in tiles up to 90mm in profile. Roof pitch 20°-90°.	£82	£84	£88	£95	£95	£99	£106	£125	£118	£117	£134

Standard flashings

Code	Description	CK02	CK04	CK06	MK04	FK06	MK06	MK08	UK04	PK08	SK06	PK10	UK08
Standard flashings including installation products (BDx 2000)													
EDL 2000	For slate up to 8mm thick. Roof pitch 15°-90°.	£81	£83	£87	£92	£92	£96	£103	£116	£111	£111	£115	£124
EDW 2000	For tiles up to 120mm in profile. Roof pitch 15°-90°.	£81	£83	£87	£92	£92	£96	£103	£116	£111	£111	£115	£124
EDT 2000	For plain tiles between 15mm - 40mm. Roof pitch 20°-90°.	£84	£86	£90	£95	£95	£99	£105	£120	£115	£115	£119	£129
Standard flashings not including installation products													
EDL 0000	For slate up to 8mm thick. Roof pitch 15°-90°.	£55	£56	£59	£63	£63	£66	£71	£83	£79	£78	£81	£89
EDW 0000	For tiles up to 120mm in profile. Roof pitch 15°-90°.	£55	£56	£59	£63	£63	£66	£71	£83	£79	£78	£81	£89
EDP 0000	For plain tiles up to 14mm thick. Roof pitch 25°-90°.	£55	£56	£59	£63	£63	£66	£71	£83	£79	£78	£81	£89
EDT 0000	For flat tiles between 15mm - 40mm. Roof pitch 20°-90°.	£58	£59	£62	£66	£66	£69	£74	£87	£83	£82	£85	£94

- ▶ All flashings have a delivery time of 2 days.
- ▶ Delivery time is in working days from receipt of orders placed before 4pm (UK) and 11.30am (NI).
- ▶ Flashing colour NCS: S 7500-N. (Nearest RAL: 7043). Flashings also available in titanium zinc, copper and a wide range of colours to match the roof window finish. See twin and combination flashings on page 44.



TWIN 18MM GAP



COUPLED 100MM GAP

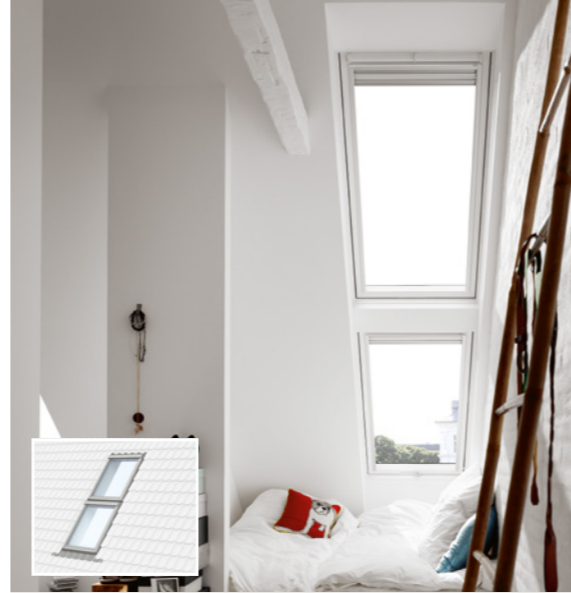

DUO 100MM GAP



TRIPLE 100MM GAP



QUATTRO 100MM GAP

Twin and combination flashings

Twin and combination flashings

External frame size (nominal w x h) cm

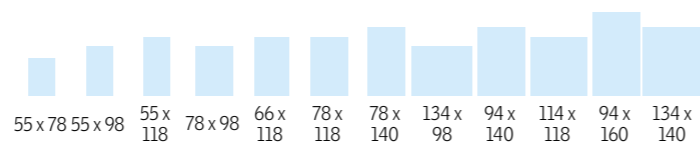

Code	Description	CK02	CK04	CK06	MK04	FK06	MK06	MK08	UK04	PK08	SK06	PK10	UK08
EKN 0021E Coupled Recessed	Side by side with 100mm gap for slate up to 8mm thick.	£206	£210	£220	£236	£236	£248	£266	£312	£296	£294	£306	£336
EKJ 0021E Coupled Recessed	Side by side with 100mm gap for tiles with max. profile 90mm.	£206	£210	£220	£236	£236	£248	£266	£312	£296	£294	£306	£336
EBL 0021B Twin	Side by side with 18mm gap for slate up to 8mm thick.	£123	£126	£132	£142	£142	£149	£159	£187	£177	£176	£183	£201
EBW 0021B Twin	Side by side with 18mm gap for tiles with a max. profile 120mm.	£123	£126	£132	£142	£142	£149	£159	£187	£177	£176	£183	£201
EBP 0021B Twin	Side by side with 18mm gap for plain tiles up to 14mm thick.	£123	£126	£132	£142	£142	£149	£159	£187	£177	£176	£183	£201
EBL 0021C Twin	Side by side with 50mm gap for slate up to 8mm thick.	£123	£126	£132	-	-	-	-	-	-	£176	-	-
EBW 0021C Twin	Side by side with 50mm gap for tiles with a max. profile 120mm.	£123	£126	£132	£142	£142	£149	£159	-	£177	£176	£183	£201
EKL 0021E Coupled	Side by side with 100mm gap for slate up to 8mm thick.	£126	£129	£135	£145	£145	£152	£162	£191	£181	£180	£187	£206
EKW 0021E Coupled	Side by side with 100mm gap for tiles with a max. profile 120mm.	£126	£129	£135	£145	£145	£152	£162	£191	£181	£180	£187	£206
EKP 0021E Coupled	Side by side with 100mm gap for plain tiles up to 14mm thick.	£126	£129	£135	£145	£145	£152	£162	£191	£181	£180	£187	£206
EKL S0122 Duo	Above/below with 100mm gap for slate up to 8mm thick.	£137	£140	£147	£157	£157	£165	£176	£207	£197	£195	£202	£223
EKW S0122 Duo	Above/below with 100mm gap for tiles with a max. profile 120mm.	£137	£140	£147	£157	£157	£165	£176	£207	£197	£195	£202	£223
EKL S0312 Triple	Side by side with 100mm gap for slate up to 8mm thick.	£189	£193	£202	£217	£217	£228	£243	£287	£272	£270	£280	£309
EKW S0312 Triple	Side by side with 100mm gap for tiles with a max. profile 120mm.	£189	£193	£202	£217	£217	£228	£243	£287	£272	£270	£280	£309
EKL S0222 Quattro	Group of 4 with 100mm gap for slate up to 8mm thick.	£290	£297	£311	£333	£333	£350	£372	£439	£417	£414	£429	£474
EKW S0222 Quattro	Group of 4 with 100mm gap for tiles with a max. profile 120mm.	£290	£297	£311	£333	£333	£350	£372	£439	£417	£414	£429	£474

- ▶ Delivery time for all coupled flashings is 2 days except coupled recessed flashings which are 7 days. All other flashings have a delivery time of 7 days except EBP 0021B which is 11 days.
- ▶ Delivery time is in working days from receipt of orders placed before 4pm (UK) and 11.30am (NI).
- ▶ Flashing colour NCS: S 7500-N. (Nearest RAL colour: 7043). Twin and combination flashings are also available in titanium zinc, copper and a wide range of colours to match the roof window finish.
- ▶ Other recessed combination flashing options are available and subject to lead times. Contact our customer support team for details on recessed Triple and Quattro options.

Support trimmers

- VELUX support trimmers provide structural support and also a harmonious finish.
- Available in white or pine to match the roof windows.
- Available in three different lengths.
- The EBY is used for frame gaps of 18mm between the roof windows and the EKY for 100mm gaps.



EBY 2000 18MM GAP



EKY 2000 100MM GAP

Opening sizes depend on the flashings used. Instructions available online.

Support trimmer for 18mm frame gap – white roof windows

EBY W20 2000	2,000mm long.	£139
EBY W27 2000	2,700mm long.	£164
EBY W35 2000	3,500mm long.	£195

Support trimmer for 100mm frame gap – white roof windows

EKY W20 2000	2,000mm long.	£232
EKY W27 2000	2,700mm long.	£274
EKY W35 2000	3,500mm long.	£325

Support trimmer for 18mm frame gap – pine roof windows

EBY W20 3000	2,000mm long.	£139
EBY W27 3000	2,700mm long.	£164
EBY W35 3000	3,500mm long.	£195

Support trimmer for 100mm frame gap – pine roof windows

EKY W20 3000	2,000mm long.	£232
EKY W27 3000	2,700mm long.	£274
EKY W35 3000	3,500mm long.	£325

Roof window profile set (For use with on-site flashing)

External frame size (nominal w x h) cm

Code	CK02	CK04	CK06	MK04	FK06	MK06	MK08	UK04	PK08	SK06	PK10	UK08
ZWC 0000T	£22	£23	£23	£24	£25	£26	£27	£30	£30	£31	£31	£34

- ▶ Support trimmers have a delivery time of 2-7 days.
- ▶ Roof window profile sets have a delivery time of 2 days.
- ▶ Delivery time is in working days from receipt of orders placed before 4pm (UK) and 11.30am (NI).

Benefits:

- Elegant solution for externally visible installations.
- Glass-to-edge construction allows for a clear, uninterrupted view.
- Low maintenance due to curved glass allowing rain to run off.
- Choose the electrically-vented base unit with VELUX INTEGRA® for comfortable, automated operation.

Roof pitch



Suitable for roof pitches between 0° and 15°.



Select your top cover and base unit to configure your flat roof window.

VELUX curved glass rooflights

The stylish solution

This rooflight has a unique curved glass surface that lets in more daylight and stands out externally as a modern addition to roof surfaces. Combining a curved glass top cover with either an electrically operated base unit or a fixed base unit will give you a value of 0.72 Urc, ref300.



Curved glass rooflight

External frame size including kerb (nominal w x h) cm
Structural openings (nominal w x h) cm

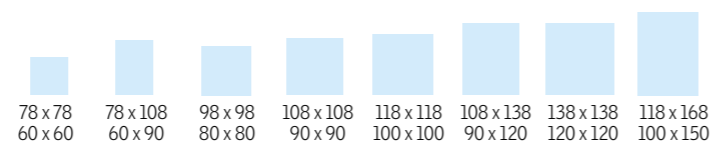

Code	Description	060060	060090	080080	090090	100100	090120	120120	100150
CHOOSE A TOP COVER									
ISD 1093	Curved glass top cover.	£397	£425	£447	£514	£559	£592	£726	£737
NOW CHOOSE A BASE, EITHER FIXED OR VELUX INTEGRA®									
Fixed									
CFP 0073QV	Fixed flat roof window base with double glazed insulating glass unit featuring laminated inner pane for safety.	£285	£306	£322	£370	£402	£426	£490	£515
VELUX INTEGRA®									
CVP0673QV	Electrically operated flat roof window base with double glazed insulating glass unit featuring laminated inner pane for safety.	£700	£721	£737	£785	£817	£841	£905	£930
Accessories									
ZCE 0015	Extension kerb 150mm (for warm roof installations only).	£169	£178	£180	£188	£194	£196	£217	£225
ZZZ 210	Frame fixing kit for roof material.	£39	£41	£41	£43	£45	£45	£50	£52

- ▶ All roof windows have a delivery time of 2 days.
- ▶ Delivery time is in working days from receipt of orders placed before 4pm (UK) and 11.30am (NI).

Select your top cover and base unit to configure your flat roof window.

Benefits:

- It comprises of a maintenance-free PVC framework and lacquered aluminium cladding.
- Highly energy efficient, our high-performance insulation is integrated into the frame to give the best possible protection against heat loss.

Roof pitch



Suitable for roof pitches between 2° and 15°.



VELUX flat glass rooflights

Convenience and high performance

Special consideration should be given for applications below roof pitch 5°: If installed below 5°, there is an increased risk of water, dirt and debris standing on the glass. Combining a flat glass top cover with either an electrically operated base unit or a fixed base unit will give you a value of 0.79 Urc, ref300.

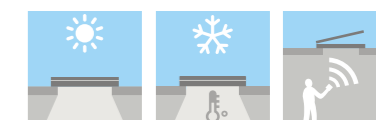

Flat glass rooflight

External frame size including kerb (nominal w x h) cm
Structural openings (nominal w x h) cm

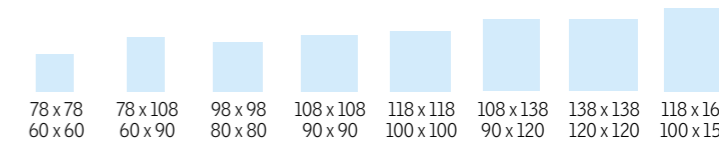

Code	Description	060060	060090	080080	090090	100100	090120	120120	100150
CHOOSE A TOP COVER									
ISD 2093	Flat glass top cover.	£310	£332	£349	£401	£436	£462	£567	£576
NOW CHOOSE A BASE, EITHER FIXED OR VELUX INTEGRA®									
Fixed									
CFP 0073QV	Fixed flat roof window base with double glazed insulating glass unit featuring laminated inner pane for safety.	£285	£306	£322	£370	£402	£426	£490	£515
VELUX INTEGRA®									
CVP0673QV	Electrically operated flat roof window base with double glazed insulating glass unit featuring laminated inner pane for safety.	£700	£721	£737	£785	£817	£841	£905	£930
Accessories									
ZCE 0015	Extension kerb 150mm (for warm roof installations only).	£169	£178	£180	£188	£194	£196	£217	£225
ZZZ 210	Frame fixing kit for roof material.	£39	£41	£41	£43	£45	£45	£50	£52

- ▶ All roof windows have a delivery time of 2 days.
- ▶ Delivery time is in working days from receipt of orders placed before 4pm (UK) and 11.30am (NI).



1. CHOOSE YOUR DOME

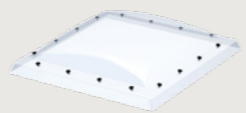

CLEAR DOME

- Clear view to the outside.
- Provides maximum daylight.
- Scratch resistant.

or

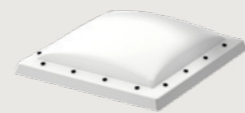

OPAQUE DOME

- Hazed transparency for full privacy.
- Provides good levels of daylight.
- Scratch resistant.

2. NOW CHOOSE A BASE UNIT

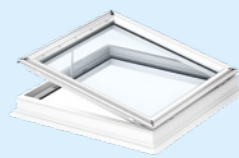

ELECTRICALLY VENTED BASE UNIT (CVP)

- High-insulated PVC sash construction.
- 2-layer low-energy pane.
- Laminated pane on the inside.
- Openable construction.
- VELUX INTEGRA® convenient operation.
- Integrated rain sensor for automatic closing during rain.

or

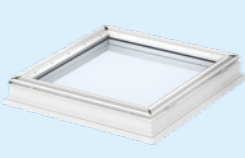

FIXED BASE UNIT (CFP)

- High-insulated PVC sash construction.
- 2-layer low-energy pane.
- Laminated pane.

VELUX flat roof domes

Roof pitch

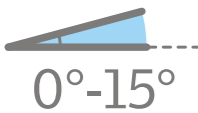

0°-15°

U-VALUES

Combining a polycarbonate dome with either an electrically operated base unit or a fixed base unit will give you a value of 0.72 Urc, ref300.

Suitable for roof pitches between 0° and 15°.

Flat roof domes

External frame size including kerb (nominal w x h) cm	78 x 78	78 x 108	98 x 98	108 x 108	118 x 118	108 x 138	138 x 138	118 x 168	168 x 168
Structural openings (nominal w x h) cm	60 x 60	60 x 90	80 x 80	90 x 90	100 x 100	90 x 120	120 x 120	100 x 150	150 x 150
Code	060060	060090	080080	090090	100100	090120	120120	100150	150150
CHOOSE A TOP COVER									
ISD 0010	Clear polycarbonate dome.	£189	£202	£213	£245	£266	£282	£346	£479
ISD 0110	Opaque polycarbonate dome.	£189	£202	£213	£245	£266	£282	£346	£479
NOW CHOOSE A BASE, EITHER FIXED OR VELUX INTEGRA®									
Fixed									
CFP 0073QV	Fixed flat roof window base with double-glazed insulating glass unit featuring laminated inner pane for safety.	£285	£306	£322	£370	£402	£426	£490	£647
VELUX INTEGRA®									
CVP 0673QVA	Electrically operated flat roof window base with double-glazed insulating glass unit featuring laminated inner pane for safety.	£700	£721	£737	£785	£817	£841	£905	£1,062
Accessories									
ZCE 0015	Extension kerb 150mm (for warm roof installations only).	£169	£178	£180	£188	£194	£196	£217	£264
ZZZ 210	Frame fixing kit for roof material.	£39	£41	£41	£43	£45	£45	£50	£61

- ▶ All roof windows have a delivery time of 2 days.
- ▶ Delivery time is in working days from receipt of orders placed before 4pm (UK) and 11.30am (NI).



- Benefits:
- Excellent insulating value and sound reduction.
 - Provides an ideal flat roof exit solution.
 - Opening angle of approximately 60°.

Roof pitch



Suitable for roof pitches between 0° and 15°.

VELUX flat roof domes – access and emergency escape

- Manually operated flat roof exit solution.
- Double-glazed roof window with polycarbonate cover.
- Clear or opaque polycarbonate cover.
- Note: this product is not compatible with VELUX flat roof blinds FMG, FMK and MSG.



Access and emergency escape

External frame size including kerb (nominal w x h) cm	118 x 118	108 x 138	138 x 138	
Structural openings (nominal w x h) cm	100 x 100	90 x 120	120 x 120	
Code	100100	090120	120120	
Top cover				
ISD 0010	Clear polycarbonate dome.	£266	£282	£346
ISD 0110	Opaque polycarbonate dome.	£266	£282	£346
Access and emergency escape				
CXP 0473Q	Manually operated flat roof window base for access or escape with double-glazed insulating glass unit featuring laminated inner pane for safety. Compatible with polycarbonate dome top covers only.	£812	£861	£991
Accessories				
ZCE 0015	Extension kerb 150mm.	£194	£196	£217
ZZZ 210	Frame fixing kit for roof material.	£45	£45	£50

- ▶ All roof windows have a delivery time of 2 days.
- ▶ Delivery time is in working days from receipt of orders placed before 4pm (UK) and 11.30am (NI).

Build your rooflights just the way you want them with VARIO by VELUX

Custom-made designs that bring endless daylight and welcome nature indoors.

You can bring your daylight dreams to life with a huge variety of shapes, colours and features to create the ultimate blend of natural light for your home.

Roof pitch



Suitable for roof pitches between 0° and 15°.



Featured: The Rectangular One, 2,970mm wide x 1,300mm long 150mm upstand, fixed, jet black. £2,641.



Why VELUX Modular Skylights?

VELUX Modular Skylights are specially designed to bring more natural light into modern, flat roof homes and extensions. Modularity allows you to design with daylight over larger roof expanses, with an end result that blends more with the surroundings.

Roof pitch



Suitable for roof pitches between 0° and 15°.

VARIO BY VELUX Bespoke Rooflights

Explore endless possibilities and combinations

Design your own rooflights

We want to make your life easy when it comes to designing with daylight. Visit our website and try our Build Your Own configurator. Create your own flat roof iconic designs suitable for roof pitches between 0° and 15°.

- Design a bespoke rooflight that fits your project with sizes going up to 4m² of clear internal glass measurement.
- See a live 3D illustration of the rooflight you are configuring.
- Get real time prices on our bespoke rooflight range.



Create your own iconic daylight designs
vario.velux.com/buildyourown

Contact us:

Email: vario@velux.co.uk
Phone: 01592 778 246

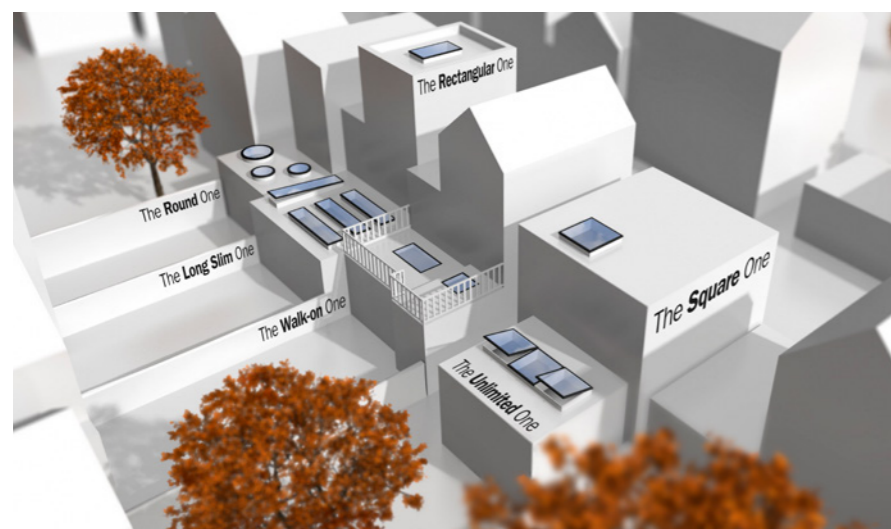

VELUX Modular Skylights

Open up larger roof expanses

Unique design

VELUX Modular Skylights offer a slim profile design, which is great for modern homes that need to make the most of the daylight. Electrics and motors within vented modules are concealed, creating a simple and refined look, inside and out.

Light up the rooms in your home

The kitchen is the heart of the home, and the range of activities we enjoy there means that the lighting must meet everyone's needs, whilst also keeping the room looking good, morning, noon and night.

With VELUX Modular Skylights, the light enters directly from above, right into the centre of your room. This is a much stronger source of illumination than limited light coming from your vertical windows.



Prices from
£1,455 ex VAT.
For more details, call
01592 778 941
or contact
vmsdomestic@velux.co.uk

For further inspiration visit
velux.co.uk/vmsdomestic



Blinds and shutters for any room

Whether you want to soften incoming daylight or block it out completely, our extensive range of blinds and shutters offers the ideal solution to suit your space. Available in a wide variety of styles and colours, you'll be able to find the perfect VELUX blind or shutter for your home.



White-line blackout blinds

Our full range of manual blackout blinds are now available with white side channels, blending in seamlessly with our white painted and white polyurethane roof windows.

Find out more on [p55](#) →



VELUX solar powered soft shutters

The new VELUX soft shutter delivers effective heat protection, keeping your home cool on sunny days and the lightweight fabric provides blackout for a better night's sleep.

Find out more on [p63](#) →

How to select your blinds

- 1 Select type**
Choose an interior and/or exterior VELUX blind or shutter that meets your requirements in terms of heat protection, blackout, light adjustment or insect protection.
- 2 Select colour and design**
Our blinds are available in an extensive range of exciting colours and designs.
- 3 Select operation method**
Choose between manual or automatic operation. Always consider electrically-operated products for out-of-reach areas.
- 4 Select the right size**
Check the data plate which displays the type and size of your roof window – you must match the blinds you order to this information. See the chart below for more details.

VELUX roof window data plates



5 Installed in minutes

VELUX interior blinds are easily installed with our unique Pick&Click!™ system. Follow the instructions, and your blinds will be fitted in minutes.

Pick&Click!™

New VELUX roof windows are fitted with pre-installed brackets to ease installation and to ensure a perfect fit every time.



All VELUX internal blinds are power operated or cordless operated and fulfil the safety in use requirements in EN 13120:2009+A1:2014 and EN 60335-2-97:2006+EN 60335-2-97:2006/A12:2015.

Sizing chart

It's simple to make sure you order the right size of blind:

- Check your roof window's data plate, then use the SIZE CODE to find its measurements on the chart below.
- Now you can check the price of your chosen blind on the following pages.
- Make sure you use the SIZE CODE on your roof window's data plate when ordering your blind at veluxblindsdirect.co.uk

	55 x 70	55 x 78	55 x 98	55 x 118	78 x 98	66 x 118	70 x 118	78 x 118	78 x 140	134 x 98	94 x 140	114 x 118	94 x 98	94 x 160	134 x 140
Current Size	CK01	CK02	CK04	CK06	MK04	FK06		MK06	MK08	UK04	PK08	SK06	PK04	PK10	UK08
2002-2013	C01	C02	C04	C06	M04	F06		M06	M08	U04	P08	S06	P04	P10	U08
1992-2001		102	104		304	206		306	308	804		606		410	808
Before 1992	9		6		1		5		2	7		4		3	8



Blackout blinds

Duo blackout blinds



The VELUX duo blind is a blackout blind and a pleated blind in one. It offers the best of both worlds: blackout at any time and softly diffused natural light all day.

- Fabric offers complete blackout.
- Stepless positioning.
- Flat and pleated cloth.
- Available in 24 colours (see opposite page).
- Softly diffuses incoming daylight.
- OEKO-TEX® certified – no harmful substances.

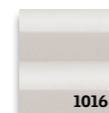

Upgrade from blackout to duo blackout for **£22** ex. VAT.

Replacement blackout blinds



Suitable for VELUX roof windows manufactured before 2014, the VELUX replacement blind is the perfect, low-cost solution to change your old or tired VELUX blinds. The best choice if you want a simple blackout blind that comes with a 2-year guarantee for peace of mind.

- Essential blackout effect.
- Stepless positioning.
- Available in 4 colours.
- **Only suitable for VELUX roof windows manufactured before 2014.**

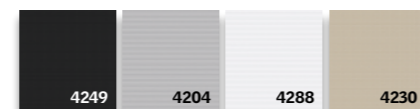

Blackout blinds



The VELUX blackout blind offers almost complete blackout for darkness anytime. Ideal for bedrooms to ensure a good night's sleep.

- Fabric offers complete blackout.
- Stepless positioning.
- Available in 24 colours.
- OEKO-TEX® certified.
- Also available in electric and solar powered options.

Use the **SIZE CODE** to order – check the sizing chart on p53.

Price Group 1



Price Group 2



White line blackout blinds

Manual blackout blinds now available with white side channels. Simply add WL to the end of your DKL product code when ordering.

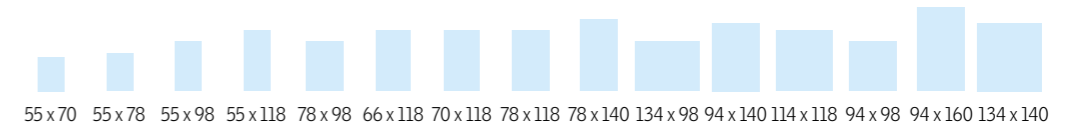

Blackout blinds. Please refer to page 53 for your product code.

			£60	£62	£66	£70	£72	£74	£74	£76	£82	£100	£90	£96	£78	£96	£110
Manual	DKL	Price Group 1															
		Price Group 2	£70	£72	£76	£80	£82	£84	£84	£86	£92	£110	£100	£106	£88	£106	£120
Electric	DML	Price Group 1	£129	£131	£135	£139	£141	£143	£143	£145	£151	£169	£159	£165	£147	£165	£179
		Price Group 2	£139	£141	£145	£149	£151	£153	£153	£155	£161	£179	£169	£175	£157	£175	£189
Solar	DSL	Price Group 1	£136	£138	£142	£146	£148	£150	£150	£152	£158	£176	£166	£172	£154	£172	£186
		Price Group 2	£146	£148	£152	£156	£158	£160	£160	£162	£168	£186	£176	£182	£164	£182	£196
Duo blackout	DFD	Price Group 1	£82	£84	£88	£92	£94	£96	£96	£98	£104	£122	£112	£118	£100	£118	£132
		Price Group 2	£92	£94	£98	£102	£104	£106	£106	£108	£114	£132	£122	£128	£110	£128	£142
Repl. blind	DBL	All colours	-	£42	£46	-	£50	£52	-	£54	£58	£70	£64	£68	-	-	£78

Electrically powered products combined with a manual VELUX roof window require a control unit KUX 110. Refer to page 65 for details.

- ▶ All blinds and shutters have a delivery time of up to 7 days.
- ▶ Delivery time is in working days from receipt of orders placed before 4pm (UK) and 11.30am (NI).



Children's collection

Disney & VELUX Goodnight Collection

The Disney & VELUX Goodnight Collection is our latest range of blackout blinds designed for kids. Inspired by their favourite characters from Frozen, Cars and Winnie the Pooh – night time has never been so much fun.

Our themed blinds will spark their imagination while they play during the day and, because the fabric offers total blackout, they'll enjoy restful sleep too.

- 99.9% blackout fabric – the best on the market!
- Installs in minutes with the unique VELUX Pick&Click!™ system.
- OEKO-TEX® certified – no harmful substances.
- Slimline design integrates perfectly with VELUX roof windows.

Use the
SIZE CODE to
order – check the
sizing chart on
p53.



Blackout blinds. Please refer to page 53 for your product code.

Manual	DKL	Disney & Goodnight Collection														
		£82	£84	£88	£92	£94	£96	-	£98	£104	£122	£112	£118	£100	£118	£132
		VELUX Dream Collection														
		£82	£84	£88	£92	£94	£96	-	£98	£104	£122	£112	£118	£100	£118	£132

- ▶ All blinds and shutters have a delivery time of up to 7 days.
- ▶ Delivery time is in working days from receipt of orders placed before 4pm (UK) and 11.30am (NI).



All VELUX internal blinds are power operated or cordless operated and fulfil the safety in use requirements in EN 13120:2009+A1:2014 and EN 60335-2-97:2006+EN 60335-2-97:2006/A12:2015.

Please note: as with all fabrics, the precise colours may vary from the printed samples. Designs shown for illustration purposes only. The blind may differ due to the fact that each design is scaled to match the specific window size.



Now available in white-line.

Disney & VELUX Goodnight Collection

VELUX Dream Collection

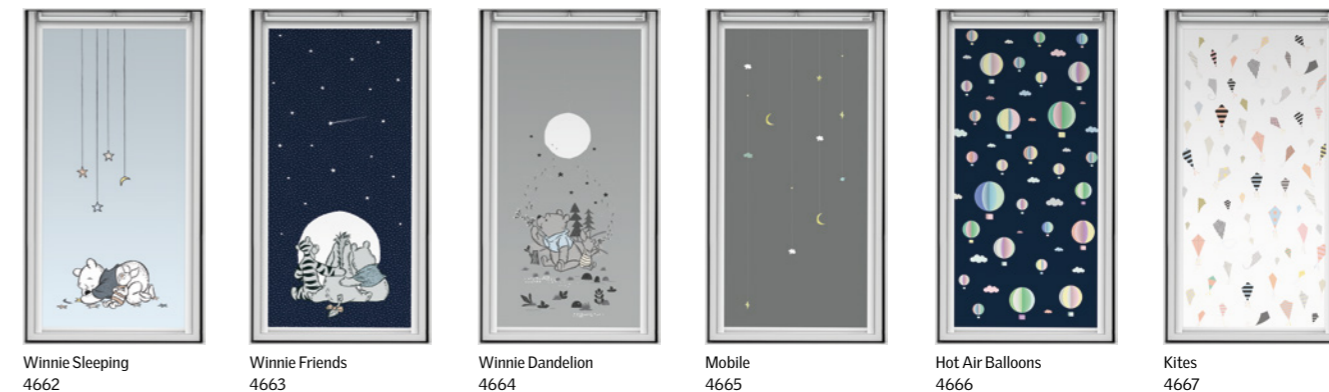

Winnie Sleeping 4662 | Winnie Friends 4663 | Winnie Dandelion 4664 | Mobile 4665 | Hot Air Balloons 4666 | Kites 4667



Cars Racetrack 4650 | Cars Moon 4651 | Cars Film Strip 4652 | Universe 4653 | Racing Cars 4654 | Roads 4655



Frozen Anna & Elsa 4656 | Frozen Northern Lights 4657 | Frozen Olaf 4658 | Pink Stars 4659 | Blue Sky 4660 | Green Stars 4661

© Disney. © Disney/Pixar.
© Disney. Based on the "Winnie the Pooh" works by A. A. Milne and E. H. Shepard.

Find the collection at veluxblindsdirect.co.uk



Improves insulation by up to **25%**

Blackout energy blinds

Blackout energy blind

- Fabric offers complete blackout.
- Stepless positioning.
- Double pleated cloth.
- Available in 12 colours.
- Installs in minutes with our unique Pick&Click!™ system.
- Free positioning in the roof window frame.
- Protects against cold from the outside.
- No visible cords.

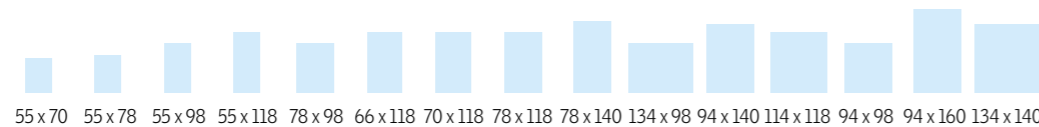
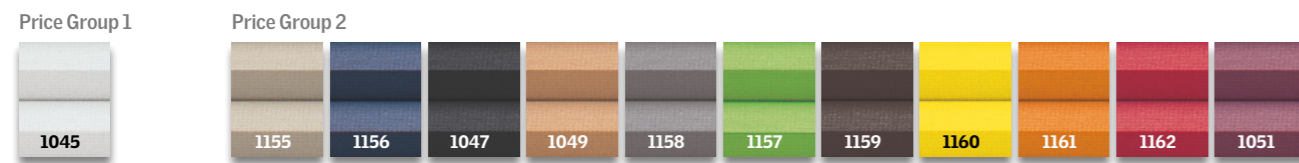

Blackout energy blinds. Please refer to page 53 for your product code.

Manual	FHC	Price Group 1	£76	£80	£86	£90	£94	£96	£96	£100	£108	£130	£118	£126	£102	£124	£144
		Price Group 2	£86	£90	£96	£100	£104	£106	£106	£110	£118	£140	£128	£136	£112	£134	£154

Light dimming energy blinds. Please refer to page 53 for your product code.

Electric	FMC	Price Group 1	£145	£149	£155	£159	£163	£165	£165	£169	£177	£199	£187	£195	£171	£193	£213
		Price Group 2	£155	£159	£165	£169	£173	£175	£175	£179	£187	£209	£197	£205	£181	£203	£223
Solar	FSC	Price Group 1	£152	£156	£162	£166	£170	£172	£172	£176	£184	£206	£194	£202	£178	£200	£220
		Price Group 2	£162	£166	£172	£176	£180	£182	£182	£186	£194	£216	£204	£212	£188	£210	£230

VELUX ACTIVE compatible

- ▶ All blinds and shutters have a delivery time of up to 7 days.
- ▶ Delivery time is in working days from receipt of orders placed before 4pm (UK) and 11.30am (NI).



Use the **SIZE CODE** to order – check the sizing chart on p53.

Pleated blinds

Flying pleated blinds

- Ideal for installing in living rooms or dining areas.
- Softens incoming light.
- Beautiful decoration for living rooms.
- Dual control bars allow you to adjust the blind from both the top and the bottom of the roof window, letting in exactly the right amount of light.
- Available in electric and solar powered options.



Pleated blinds. Please refer to page 53 for your product code.

Manual	FHL	Price Group 1	£60	£62	£66	£70	£72	£74	£74	£76	£82	£100	£90	£96	£78	£96	£110
		Price Group 2	£70	£72	£76	£80	£82	£84	£84	£86	£92	£110	£100	£106	£88	£106	£120
Electric	FML	Price Group 1	£129	£131	£135	£139	£141	£143	£143	£145	£151	£169	£159	£165	£147	£165	£179
		Price Group 2	£139	£141	£145	£149	£151	£153	£153	£155	£161	£179	£169	£175	£157	£175	£189
Solar	FSL	Price Group 1	£136	£138	£142	£146	£148	£150	£150	£152	£158	£176	£166	£172	£154	£172	£186
		Price Group 2	£146	£148	£152	£156	£158	£160	£160	£162	£168	£186	£176	£182	£164	£182	£196

VELUX ACTIVE compatible

- ▶ All blinds and shutters have a delivery time of up to 2-7 days.
- ▶ Delivery time is in working days from receipt of orders placed before 4pm (UK) and 11.30am (NI).



Roller blinds

The VELUX roller blind provides basic privacy whilst still allowing natural light in.

That's why roller blinds are well suited for living rooms, home offices, playrooms, or anywhere you want basic privacy and the ability to diffuse light.

- Softens the incoming light.
- Available in electric and solar powered operation.

Use the SIZE CODE to order – check the sizing chart on p53.

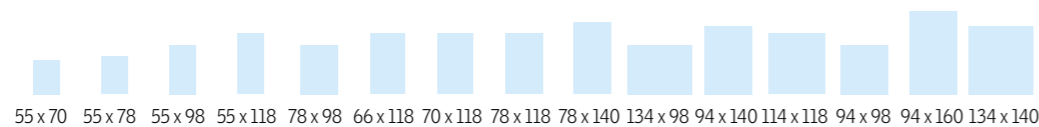
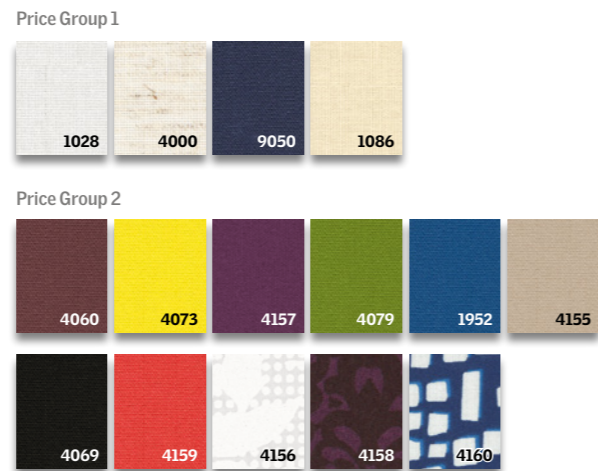

Roller blinds. Please refer to page 53 for your product code.

Manual	RFL	Price Group 1	£60	£62	£66	£70	£72	£74	£74	£76	£82	£100	£90	£96	£78	£96	£110
		Price Group 2	£70	£72	£76	£80	£82	£84	£84	£86	£92	£110	£100	£106	£88	£106	£120
Electric	RML	Price Group 1	£129	£131	£135	£139	£141	£143	£143	£145	£151	£169	£159	£165	£147	£165	£179
		Price Group 2	£139	£141	£145	£149	£151	£153	£153	£155	£161	£179	£169	£175	£157	£175	£189
Solar	RSL	Price Group 1	£136	£138	£142	£146	£148	£150	£150	£152	£158	£176	£166	£172	£154	£172	£186
		Price Group 2	£146	£148	£152	£156	£158	£160	£160	£162	£168	£186	£176	£182	£164	£182	£196

VELUX ACTIVE compatible

Electrically powered products combined with a manual VELUX roof window require a control unit KUX 110. Refer to page 65 for details.

- ▶ All blinds and shutters have a delivery time of up to 2-7 days.
- ▶ Delivery time is in working days from receipt of orders placed before 4pm (UK) and 11.30am (NI).

Venetian blinds



The VELUX Venetian blinds are easy to wipe clean and are an ideal solution for rooms with high levels of humidity.

- Control the amount and direction of incoming light and shadows.
- Praised for the unique tilt mechanism and cordless operation.
- Choose from 9 colour choices.



Use the SIZE CODE to order – check the sizing chart on p53.

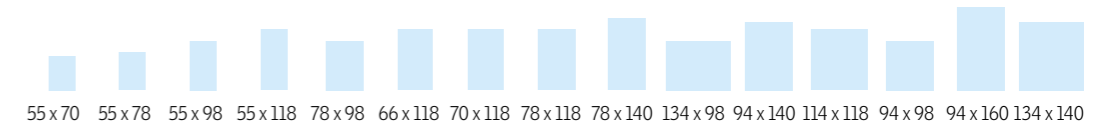

Venetian blinds. Please refer to page 53 for your product code.

Manual	PAL	Price Group 1	£76	£80	£86	£90	£94	£96	£96	£100	£108	£130	£118	£126	£102	£124	£144
		Price Group 2	£86	£90	£96	£100	£104	£106	£106	£110	£118	£140	£128	£136	£112	£134	£154

- ▶ All blinds and shutters have a delivery time of up to 2-7 days.
- ▶ Delivery time is in working days from receipt of orders placed before 4pm (UK) and 11.30am (NI).

Roman blinds

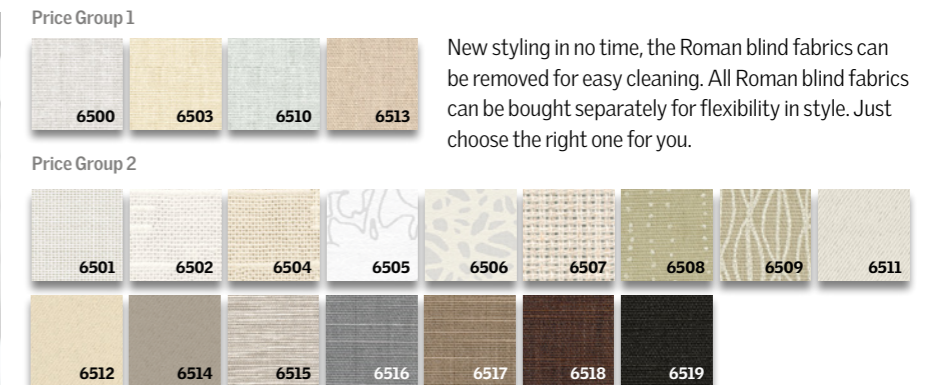

New styling in no time, the Roman blind fabrics can be removed for easy cleaning. All Roman blind fabrics can be bought separately for flexibility in style. Just choose the right one for you.

Create a soft and warm atmosphere with the decorative VELUX Roman blinds. Explore the potential of beautiful fabrics and be inspired.

- Choose from 20 elegant and decorative colours.
- Interchangeable fabrics.
- Fabric can be removed for easy cleaning.

Roman blinds. Please refer to page 53 for your product code.

Manual	FHB	Price Group 1	£76	£80	£86	£90	£94	£96	£96	£100	£108	£130	£118	£126	£102	£124	£144
		Price Group 2	£86	£90	£96	£100	£104	£106	£106	£110	£118	£140	£128	£136	£112	£134	£154
Repl. cloth for Roman blind	ZHB	Price Group 1	£38	£40	£42	£44	£46	£48	£48	£50	£54	£64	£58	£62	£52	£62	£72
		Price Group 2	£48	£50	£52	£54	£56	£58	£58	£60	£64	£74	£68	£72	£62	£72	£82

- ▶ All blinds and shutters have a delivery time of up to 2-7 days except the Roman blind (FHB) which is 13 days.
- ▶ Delivery time is in working days from receipt of orders placed before 4pm (UK) and 11.30am (NI).



External awning blinds

The VELUX awning blind is an external blind perfectly suited to stop strong sunlight and heat before it reaches the pane on your roof window. These unique blinds are ideal for keeping rooms cool and reducing the heat of the sun on hot days.

- Reduce heat by up to 76%.
- Weather resistant fabric for longer lasting performance.
- Install from the inside in minutes.
- Available in electric and solar powered operation.

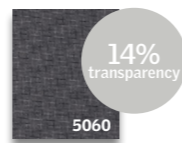

Awning blinds for flat roof windows available on p64. →



Awning blinds.																
Manual	MHL	£44	£44	£44	£44	£54	£54	£56	£54	£54	£74	£60	£70	£60	£60	£74
Electric	MML	£192	£192	£206	£212	£220	£222	£222	£230	£244	£264	£262	£268	£236	£276	£308
Solar	MSL	£260	£260	£278	£286	£296	£298	£298	£310	£328	£358	£354	£360	£320	£372	£416

For roof windows manufactured before April 2001 you must also order Z0Z 228 to fit awning blinds MML and MSL. £35

Z0Z 213K	Adaptor plate allows operation of solar powered roof windows with MSL.	£56
Z0Z 229	Installation kit which allows installation of solar and electric awning blinds with GPU VELUX INTEGRA® roof windows.	£40

Electrically powered products combined with a manual VELUX roof window require a control unit KUX 110. Refer to page 65 for details.

- ▶ All awning blinds and accessories have a delivery time of up to 2-7 days.
- ▶ Delivery time is in working days from receipt of orders placed before 4pm (UK) and 11.30am (NI).

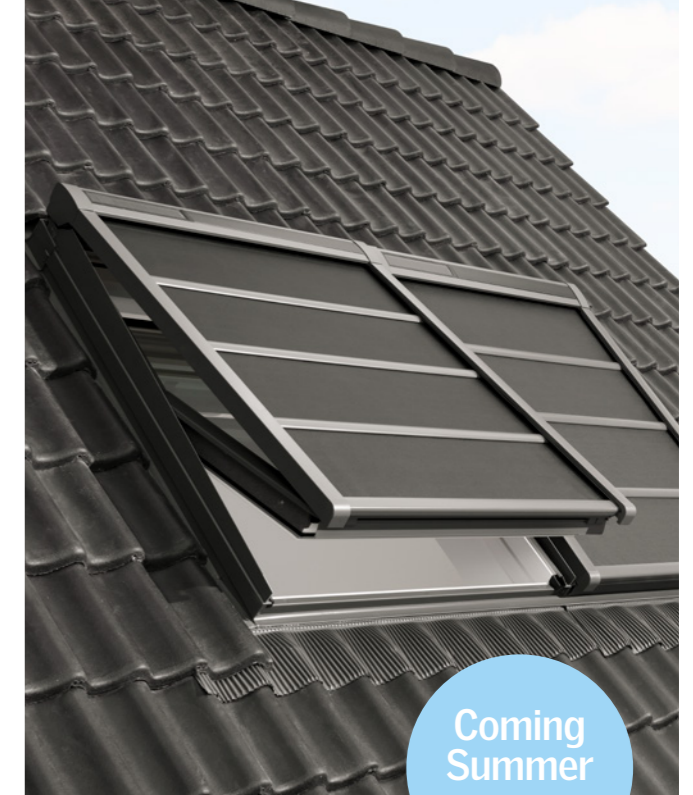

Shutters

Roller shutters

- Keeps out the light and prevents overheating.
- Provides insulation in cold weather.
- Provides additional security and protection from the elements.



Soft shutters

- Integrates perfectly into the roof and comes complete with a pre-paired wall switch for easy operation and a fast, hassle-free installation.
- Provides additional sound insulation against rainfall and hail.

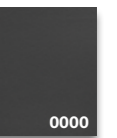

Roller shutters																
Electric	SML	£321	£321	£343	£354	£365	£369	£369	£383	£405	£442	£438	£445	£394	£460	£515
Solar	SSL	£402	£402	£429	£443	£456	£461	£461	£479	£506	£552	£548	£557	£493	£575	£643

Soft shutter																
Solar	SSS	£305	£305	£326	£336	£347	£350	-	£364	£385	£420	£416	£423	£374	£437	£489

Roller Shutter for GPU VELUX INTEGRA® electric top hung roof window																
Solar	SMH	-	-	-	-	-	£516	-	£537	£567	-	£613	£623	-	-	-

Electrically powered products combined with a manual VELUX roof window require a control unit KUX 110. Refer to page 65 for details.

- ▶ All shutters have a delivery time of up to 5-7 days.
- ▶ Delivery time is in working days from receipt of orders placed before 4pm (UK) and 11.30am (NI).



Flat roof blinds

Blinds for flat roof windows.

Window size	060060	060090	080080	090090	100100	090120	120120	100150	150150
FMG Electric pleated blinds	£223	£226	£230	£235	£240	£245	£250	£254	-
FMK Electric light dimming energy blinds	£243	£246	£250	£255	£260	£265	£270	£274	£320
FSK Solar light dimming energy blind	£248	£251	£255	£260	£265	£270	£275	£279	£325
KUX 110 – Additional control system to allow FMG and FMK blind to be fitted to CFP fixed version.									£101

VELUX
ACTIVE
compatible

FMG – Electric pleated



FMK and FSK – Light dimming energy

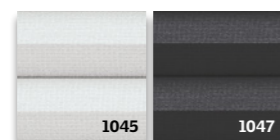

Electrically powered products combined with a manual VELUX roof window require a control unit KUX 110. Refer to page 65 for details.

- ▶ All blinds and shutters have a delivery time of up to 7 days.
- ▶ Delivery time is in working days from receipt of orders placed before 4pm (UK) and 11.30am (NI).

Awning blinds for flat roof windows

MSG solar powered heat-reduction awning blind. Available in white (6090). Not compatible with VELUX flat glass top covers.

Window size	060060	060090	080080	090090	100100	090120	120120	100150	150150
MSG solar heat reduction awning blinds	£248	£251	£255	£260	£265	£270	£275	£279	-

Electrically powered products combined with a manual VELUX roof window require a control unit KUX 110. Refer to page 65 for details.

- ▶ All blinds and shutters have a delivery time of up to 2-7 days.
- ▶ Delivery time is in working days from receipt of orders placed before 4pm (UK) and 11.30am (NI).

Accessories

Rod controls

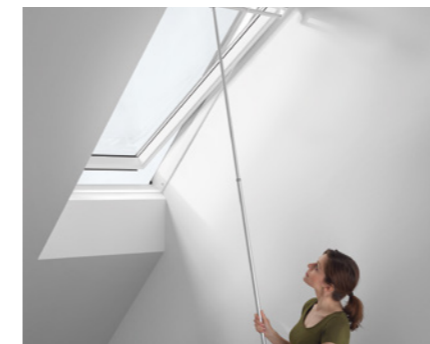

ZCT 200K

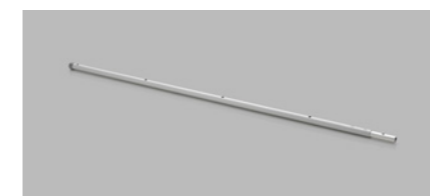

ZCT 100



ZOZ 085

Locks and restrictors



ZOZ 012K1



ZOZ 010KC S011



Electric accessories

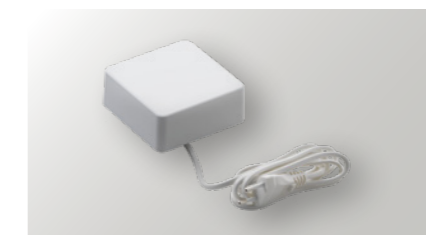

KUX 110

Maintenance kits



ZZZ 129KC



ZZZ 130KC



ZZZ 131KC

Code	Description	Price
Rod controls		
ZCT 200K	Telescopic pole 100-180cm for operation of centre-pivot roof windows.	£27
ZCT 100	100cm extension for ZCT 200K.	£16
ZOZ 085	Pole adaptor for VELUX manual blinds that are out of reach to allow operation with rod control (ZCT 200K). One per blind.	£6
Locks and restrictors		
ZOZ 012K1	Security lock for centre-pivot roof windows.	£45
ZOZ 010KC S011	Opening restrictor with key for centre-pivot roof windows. Suitable for roof windows of frame height 98cm and above.	£45
Maintenance kits		
ZZZ 129KC	Polyurethane paint for repair to white polyurethane roof windows.	£12
ZZZ 130KC	White paint for repair to white paint roof windows.	£12
ZZZ 131KC	Care kit for white painted roof windows. Includes cleaning solution, maintenance protector and cloth.	£28
Electric accessories		
KUX 110	Control system for operation of single electrical accessory on a manual roof window or fixed flat roof window.	£101

- ▶ All rod controls have a delivery time of 2 days.
- ▶ All locks and restrictors have a delivery time of 5 days.
- ▶ All maintenance kits have a lead time of 2-5 working days.
- ▶ All electric accessories have a delivery time of 7 days.
- ▶ Delivery time is in working days from receipt of orders placed before 4pm (UK) and 11.30am (NI).

VELUX accessories

* All VELUX internal blinds are power operated or cordless operated and fulfil the safety in use requirements in EN 13120:2009+A1:2014 and EN 60335-2-97:2006+EN 60335-2-97:2006/A12:2015.

VELUX Company Ltd
Woodside Way
Glenrothes
Fife
Scotland
KY7 4ND
Tel: 01592 778 225
Fax: 01592 776 980
Email: sales@velux.co.uk
Website: velux.co.uk

 facebook.com/VELUXGBI

 twitter.com/VELUXGBI

 pinterest.com/VELUXGBI

 instagram.com/VELUX

Bringing light to life™



VELUX
product range